

Detailed manual

DC-R302

Portable recorder

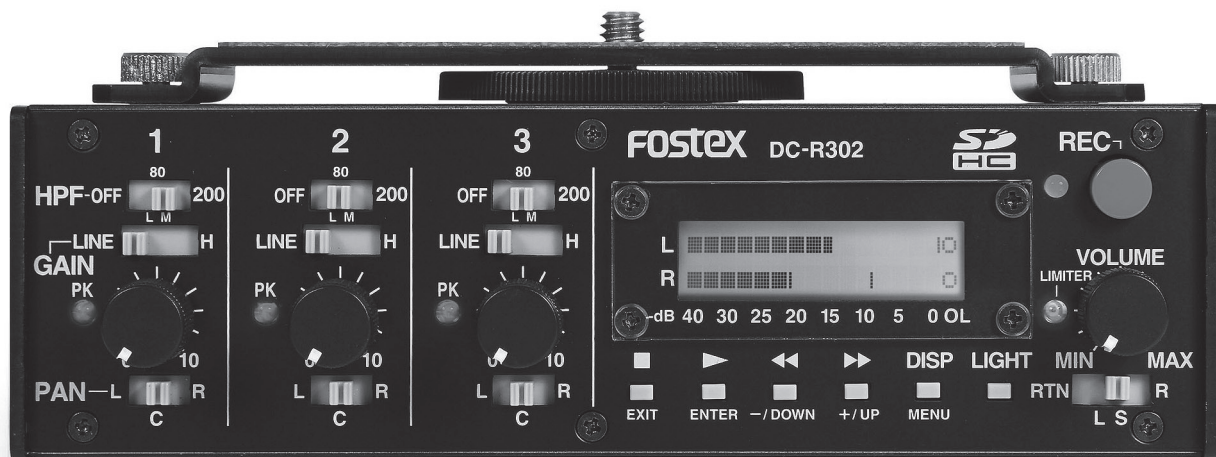

Table of Contents

Introduction	3	Using menu	16
Overview	3	Basic menu operations	16
Main Features	3	Menu item list	16
Features and controls	4	Menu item details	17
Preparations	9	Selecting recording format [FS/BIT]	17
SD card	9	Generating the record start tone [ToneRec Start]	17
Inserting an SD card	9	Generating the record end tone [ToneRec End]	18
Power supply	9	Selecting the record stop key [REC STOP KEY]	18
Preparing the power supply	9	Selecting the default file name [DEF. FILENAME]	19
Display for showing battery status	9	Activating the USB mode [USB]	19
Remaining	9	Selecting the battery type [BATTERY]	20
Alert message	9	Selecting the infrared controlled device	
Basic operations	10	[IR REMOTE]	20
Power on/off	10	Formatting an SD card [SD FORMAT]	21
Internal realtime clock setting	10	Adjusting the realtime clock [RTC]	21
Backup battery for the realtime clock	10	Resetting menu items [RESET]	22
Input connection and setting	11	Viewing the software version [Version x.xx]	22
Monitoring	12	File management	23
Mixer setting	12	Automatic file management	23
Recording	13	Creating a new folder	23
Basic recording operations	13	Deleting a file	23
Settings for recording	13	Deleting all folders and files	23
Recording format	13	Display details	24
Record stop key	13	Level meters	24
Default file name	13	File name + elapsed time	24
Record start tone	14	File name + remaining time	24
Record end tone	14	Recording setting information	25
Playback	15	Power supply status	25
Playable FS/bit combination	15	USB function	25
Selecting a file	15	Using the unit with a DSLR	26
Basic playback operations	15	Mounting a DSLR to the unit	26
Outputting audio	15	Starting/stopping DSLR recording	
Outputting a reference tone	15	in sync with the unit	26
		Selecting the infrared controlled device type	26
		Sending audio to a DSLR	26
		Using camera accessories	27
		Using a tripod	27
		Using a remote shutter release for	
		controlling the unit	27
		Alert and error messages	28
		Alert messages	28
		Error messages	28
		Specifications	29
		Analog audio inputs/outputs	29
		Other connectors	29
		Peak limiter	29
		HPF (High Pass Filter)	29
		Performance	29
		General	30
		External dimensions	30
		Block diagram	31

Introduction

Thank you very much for purchasing the Fostex DC-R302 portable recorder.

To ensure the best performance, read this manual thoroughly before using the unit. Keep this manual handy for future reference.

Overview

The DC-R302 is a portable recorder with 3-ch audio mixer ideal for DSLR video recording. Audio signal is fed to DSLR while recording to an SD card. A DSLR camera can be mounted on the top.

Main Features

- Stereo SD card recorder with analog 3-channel audio mixer.
- A detachable camera mount bracket on the top panel.
- Tripod screw holes on the bottom for mounting on a various camera rig.
- Also usable as an independent portable mixer/recorder by detaching the camera mount bracket.
- Remote Start function allows DSLR camera's video recording start and stop in sync with the press of the [REC] key using infra-red connection.
- Record start and stop using off the shelf wired remote shutter release (Panasonic DMW-RS1 or equivalent).
- Each of three inputs accepts mic to line level offering the limiter and HPF for eliminating distortion caused by overload and removing unwanted low frequency range.
- 48 V phantom power allows use of condenser microphones.
- Mic level output equipped in addition to the line output to send stereo mix to a DSLR camera.
- Headphone monitoring with selections of left/stereo/right/return.
- Auto slate tone (1 kHz/sine wave) function convenient for subsequent synchronization.
- Recording stereo WAV file in 16 bit - 44.1/48 kHz or 24 bit - 44.1/48/96 kHz to SD (SDHC) card.
- USB connector for file transfer as well as USB audio for PC recording and live streaming.
- Powered by 4 x AA batteries (in a detachable battery case) or the optional power supply unit (AD15-3200) or an external DC (9-24V).
- Robust but light weight chassis made of extruded aluminum.

Features and controls

Front panel

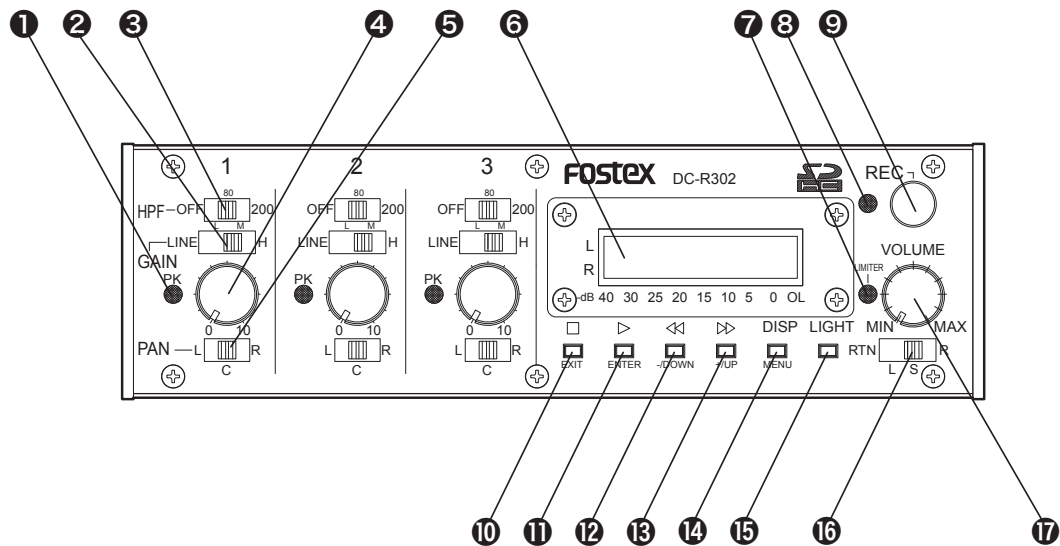

① [PK] indicators (1 through 3)

Each indicator provides a visual overload warning at the input stage.

When an input signal after the level control reaches 3 dB below the internal maximum level, the indicator shows red (see “Input connection and setting” on page 11).

<Hint>: If the [PK] indicator lights in red frequently, select the [GAIN] switch to the next left position or place the microphone farther away from the audio source.

② [GAIN] switches (1 through 3)

Each switch selects the input gain of the corresponding [INPUT] connector on the left side panel (see “Input connection and setting” on page 11).

- LINE: Accepts -10 dBu line level signals.
- L: Accepts -50 dBu mic level signals.
- M: Accepts -55 dBu mic level signals.
- H: Accepts -60 dBu mic level signals.

<Hint>: Each switch should be set appropriately according to the microphone sensitivity or the volume of an audio source.
If the [PK] indicator lights in red frequently, select the [GAIN] switch to the next left position or place the microphone farther away from the audio source.

③ [HPF] switches(1 through 3)

Each switch selects whether or not applying the high-pass filter to the audio source of the corresponding input channel (see “Input connection and setting” on page 11).

- OFF: The high-pass filter is not applied.
- 80: The high-pass filter with an 80 Hz cutoff frequency (at -6 dB/oct) is applied.
- 200: The high-pass filter with a 200 Hz cutoff frequency (at -6 dB/oct) is applied.

<Hint>: When an input signal from the [INPUT] connector contains suppressing wind or other low frequency noise, you can remove it by setting this switch to “80” or “200”.

④ Level controls (1 through 3)

Each level control adjusts the amount of the corresponding input signal sent to the recorder’s left and right tracks (see “Mixer setting” on page 12).

<Memo>: If you set the level control to maximum, the level meter shows -12 dBFS when the unit receives an input signal at nominal level.

<Hint>: The recorder records the summed signal of three input signals. You can check the recording level via the level meters on the display. To record without distortion, make sure that the “OL” indicators at the right of the level meters do not light.

⑤ [PAN] switches (1 through 3)

Each switch selects the destination (recorder tracks) of the input signal. In other words, each switch determines the stereo position of the signal (see “Mixer setting” on page 12).

- L: The signal is sent to the left track.
- C: The signal is sent equally to both the right and left tracks. In result, the signal is positioned at the center of the stereo image.
- R: The signal is sent to the right track.

⑥ Display

In the normal mode, the display can show the level meters, file name, time, battery condition, setting information, etc (see “Display details” on page 24).

In the menu mode, the display shows any one of menu item screens.

Features and controls

Front panel

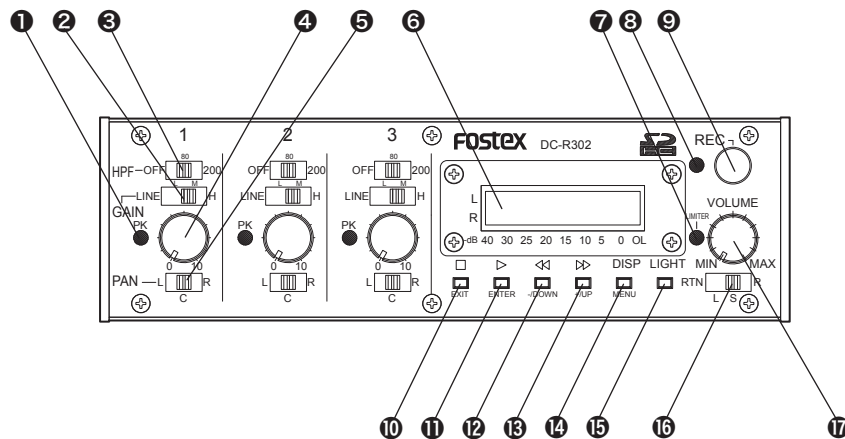

7 [LIMITER] indicator

If the recording signal is too loud, the internal limiter automatically reduce the peak level to prevent the signal distortion. When the limiter is active, this indicator lights in yellow (see “Mixer setting” on page 12).

<Memo>: The limiter circuit is also provided in each input gain section, however, the [LIMITER] indicator does not light when this limiter is active.

8 Status indicator

Lights in red during recording.
Lights in green during playback.
Flashes in green while loading a file.
Flashes in green when no SD card is set.
Flashes in green when the battery voltage is low.
Lights or flashes in orange when a USB connection is established between the unit and a computer.

9 [REC] key

Starts or stops recording.
While the recorder is stopped, pressing this key starts recording.
During recording, pressing this key stops recording and closes the file.
In the menu mode, when an execution confirmation screen is displayed, pressing this key and the [ENTER] key simultaneously starts execution.

10 [■] ([EXIT]) key

[■] key function:
Stops playback.

[EXIT] key function:
Used for exiting the menu mode or canceling the menu operation, etc.

Other functions:

By pressing a specific key while holding down this key, you can do the following operations.

- [■] key + [▶▶] key:
Changes the current folder to the next folder.

- [■] key + [◀◀] key:
Changes the current folder to the previous folder.
- [■] key + [DISP] key:
Deletes the current file.
- [■] key + [LIGHT] key:
Generates the 1 kHz tone.

<Memo>: You can assign the record stop function to this key using the “REC STOP KEY” item in the menu mode (see “Setting the record stop key” on page 18).

11 [▶] ([ENTER]) key

[▶] key function:
Starts playback while the recorder is stopped.

<Memo>: If you press this key after recording is finished, the recorder returns to the beginning of the current file and starts playback.

[ENTER] key function:
Used for executing the operation or proceeding to the next step, etc. in the menu mode.

12 [◀◀] ([-/DOWN]) key

[◀◀] key function:
While the recorder is stopped, pressing the key briefly skips back to the beginning of the file*. Pressing and holding down the key rewinds the file at 100 x speed.
During playback, pressing the key briefly skips back to the beginning of the file*. Pressing and holding down the key executes backward cueing playback (the cueing speed gradually increases while holding down the key).
During recording, this key is disabled.

* If you press the key briefly when the current position is within two seconds from the beginning of the file, the recorder skips back to the beginning of the previous file. If you press the key briefly when the current position is more than two seconds from the beginning of the file, the recorder skips back to the beginning of the current file.

Features and controls

Front panel

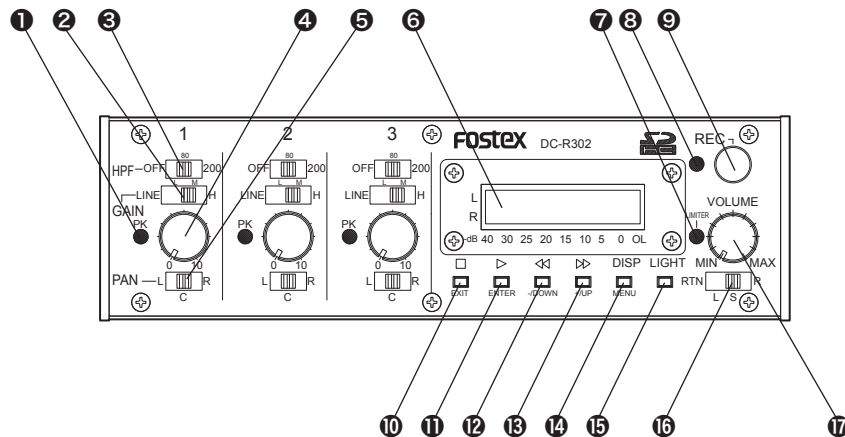

[–/DOWN] key function:

Changes a parameter value in the menu mode.

Other function:

By pressing this key while holding down the [■] key, you can change the current folder to the previous folder.

13 [▶▶] ([+/UP]) key

[▶▶] key function:

While the recorder is stopped, pressing the key briefly skips forward to the beginning of the next file. Pressing and holding down the key fast-forwards the file at 100 x speed.

During playback, pressing the key briefly skips forward to the beginning of the next file. Pressing and holding down the key executes forward cueing playback (the cueing speed gradually increases while holding down the key).

During recording, this key is disabled.

[+ /UP] key function:

Changes a parameter value in the menu mode.

Other function:

By pressing this key while holding down the [■] key, you can change the current folder to the next folder.

14 [DISP] ([MENU]) key

[DISP] key function:

Pressing the key briefly changes the displayed item (see “Display details” on page 24).

[MENU] key function:

Pressing the key for more than two seconds enters the menu mode. In the menu mode, pressing the key changes the menu item.

Other function:

By pressing this key while holding down the [■] key, you can delete the current file.

15 [LIGHT] key

By pressing the key briefly, the display backlight turns on for two seconds and then turns off.

By pressing and holding down the key for more than two seconds, the display backlight keeps lighting until you press and hold down the key for more than two seconds again.

<Memo>: The on/off condition of the display backlight is memorized when the unit is turned off.

By pressing this key while holding down the [■] key, you can generate and output a 1 kHz tone (see “Outputting a reference tone” on page 15).

16 Headphone monitor source selector

Selects the headphone monitor source.

- RTN: Input signal from the [RTN IN] jack
- L: Left channel signal of the recorder
- ST: Left and right channel signals of the recorder in stereo
- R: Right channel signal of the recorder

17 [VOLUME] control

Controls the headphone volume.

Features and controls

Left side panel

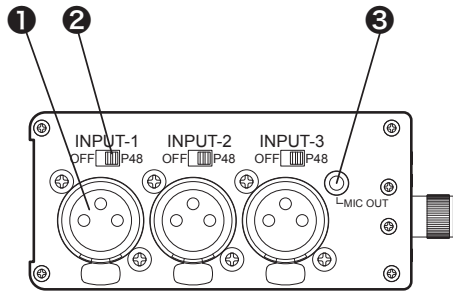

❶ [INPUT] connectors (1 through 3)

These connectors are used for connecting microphones or external audio devices (see “Input connection and setting” on page 11).

The connector type is XLR 3-pin female (pin 2 = hot).

You can select the input sensitivity using the [GAIN] switch on the front panel.

❷ Phantom power switches (1 through 3)

These switches select on/off of 48 V phantom power supply.

At the “P48” position, the 48 V voltage is supplied to the hot and cold pins of the XLR connector (see “Input connection and setting” on page 11).

<Caution>: Do not plug or unplug a microphone when the switch is set to “P48”. If you do so, a big click noise may be generated.

❸ [MIC OUT] connector [3.5 mm mini jack]

This connector outputs the same stereo signal as fed to the recorder at -50 dBV nominal level (see “Sending audio to a DSLR” on page 26).

The connector is a 4-pole mini jack with pin assignment as follows (showing a plug for convenience).

- 1: left audio channel
- 2: right audio channel
- 3: remote output
- 4: GND

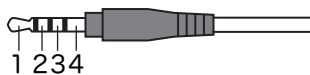

Though the connector is a 4-pole mini jack, use a standard 3-pole mini plug when you send audio to an external device. (There is no problem if the remote output terminal is short-circuited.)



- 1: left audio channel
- 2: right audio channel
- 3: GND

Right side panel

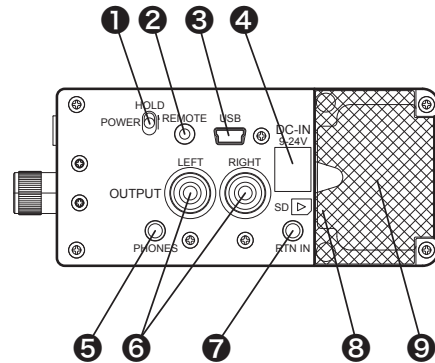

❶ [POWER] switch

Used to turn the power on or off.

While the power is off, you can turn on the power by sliding up and release the switch.

While the power is on, you can turn off the power by sliding up and holding the switch for two seconds.

<Memo>: During playback or recording, you cannot turn off the power.

❷ [REMOTE] connector [2.5 mm mini jack]

Used to connect a Panasonic (or equivalent) remote shutter release.

You can start or stop the unit recording using a remote shutter release (see “Using a remote shutter release for controlling the unit” on page 27).

The connector is a 4-pole mini jack with pin assignment as follows (showing a plug for convenience).

- 1: (Unused)
- 2: (Unused)
- 3: remote
- 4: GND



❸ [USB] connector

Connects to a personal computer using a USB cable.

Via USB, you can transfer audio data as well as copy an audio file from the unit to a computer (see “USB function” on page 25).

❹ [DC-IN] connector

Connects to the optional AC adaptor (AD15-3200) or an external battery pack.

When a plug is connected to this connector, the internal battery power (from AA batteries) is disabled.

Features and controls

Right side panel

<Memo>: When you connect an external battery pack, use a center positive 5.5 mm outer diameter x 2.1 mm inner diameter plug and supply 9 V to 24 V power.

<Caution>: Please ensure that the power is off when you connect or disconnect a plug.

⑤ [PHONES] connector [3.5 mm mini jack]

Connects stereo headphones.
The connector is a stereo mini jack.

⑥ [OUTPUT] connectors (L and R)

These connectors output the stereo mix signal in the stop or recording mode, while they output the stereo playback signal in the playback mode.
The connectors are unbalanced RCA jacks and the nominal output level is -10 dBV.

⑦ [RTN IN] connector [3.5 mm mini jack]

Connects to the stereo output of an external audio device.

You can monitor the signal received from this connector using headphones connected to the [PHONE] connector.

The connector is a stereo mini jack and the nominal output level is -10 dBV.

⑧ [SD-CARD] slot

This SD card slot is located inside the cover (see "SD card" on page 9).

To set an SD card to the slot, hold an SD card with the label side facing to the battery case compartment and press the card into the slot until you hear a click.

To remove an SD card, firmly press the card into the slot and release it. The card should pop partially out of the slot. Remove the card from the slot.

<Memo>: You can use the following SD card types.
SD, SDHC, MiniSD, MiniSDHC,
MicroSD, MicroSDHC

* When you use a MiniSD, MiniSDHC, MicroSD or MicroSDHC card, an SD card adaptor is needed.

* You cannot use an SDXC card.

⑨ Battery case compartment

To run the unit on battery power, insert the supplied battery case with four AA batteries to this compartment.

To remove battery case, open the cover and pull the ribbon attached to the battery case to lift the case from the compartment.

It is recommended to use alkaline or Ni-MH batteries (see "Preparing the power supply" on page 9).

Top panel

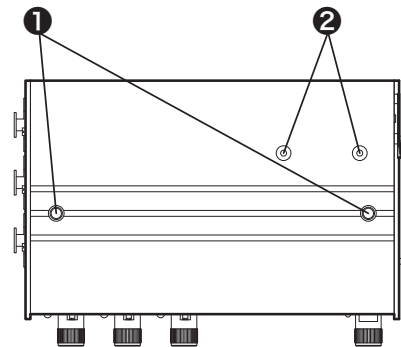

① Screw holes for camera mount bracket

These holes are used for fixing the supplied camera mount bracket. The bracket is used for mounting a DSLR to the unit (see "Mounting a DSLR to the unit" on page 26).

② Infrared transmitter

Transmits the signal for controlling a DSLR that can accept infrared remote start/stop signal. A DSLR can start or stop recording in sync with the unit (see "Starting/stopping DSLR recording in sync with the unit" on page 26).

Bottom panel

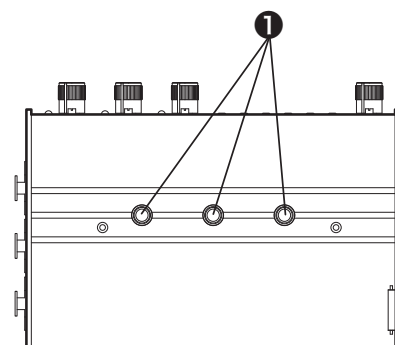

① Tripod screw holes

Used for mounting the unit on a camera tripod, etc. Three holes are provided (see "Using a tripod" on page 27).

Preparations

SD card

The unit records audio to an SD card.

You can use the following SD card types.

SD, SDHC, MiniSD, MiniSDHC,
MicroSD, MicroSDHC

* When you use a MiniSD, MiniSDHC, MicroSD or MicroSDHC card, an SD card adaptor is needed.

* You cannot use an SDXC card.

[Inserting an SD card]

This SD card slot is located inside the cover on the right side panel.

To set an SD card to the slot, hold an SD card with the label side facing to the battery case compartment and press the card into the slot until you hear a click.

To remove an SD card, firmly press the card into the slot and release it. The card should pop partially out of the slot. Remove the card from the slot.

Power supply

[Preparing the power supply]

The unit is powered by AA batteries, the optional AC adaptor (AD15-3200) or external battery pack.

● AA batteries

Use four AA alkaline or Ni-MH batteries.

The following describes how to set batteries inside the unit.

1. Insert four AA alkaline or Ni-MH batteries to the supplied battery case in the printed direction.
2. Open the cover on the right side panel and insert the battery case to the battery case compartment with the printing side facing to the SD slot.
3. Close the cover.

<Memo>: To remove battery case, open the cover and pull the ribbon attached to the battery case to lift the case from the compartment.

<Memo>: When you use battery power, set the "BATTERY" menu item in the menu appropriately to display the battery status and alert message correctly (see "Selecting the battery type" on page 20).

● AC adaptor

Connect the optional AC adaptor (AD15-3200) to the [DC-IN] connector.

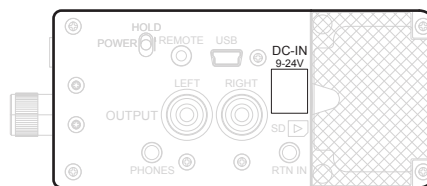

● External battery pack

Connect an external battery pack to the [DC-IN] connector.

Use a center positive 5.5 mm outer diameter x 2.1 mm inner diameter plug and supply 9 V to 24 V power.

<Memo>: When a power plug is connected to the [DC-IN] connector, the internal battery power (from AA batteries) is disabled.

[Display for showing battery status]

Remaining

When the unit is powered by AA batteries, you can see the screen as below by pressing the [DISP] key as many times as required.

```
BATT:■■■■■■■■■■  
VOLT: 4.4/ALKALI
```

The upper row shows the battery remaining meter, while the lower row shows the battery voltage and type.

Alert messages

When the battery voltage is low and the remaining meter drops to two bars, the display shows the following alert and the status indicator flashes in green.

```
* Battery:Low *  
* [Clear]:MENU *
```

When the battery voltage is further lower and the remaining meter drops to zero, the display shows the following alert.

```
* Battery:Empty *  
* [Clear]:MENU *
```

Basic operations

Power on/off

Using the [POWER] switch on the right side panel, you can turn on or off the unit.

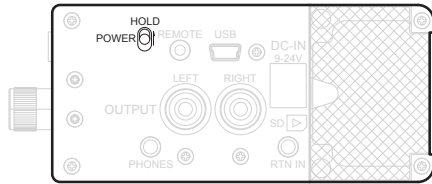

While the unit is off, sliding the switch in the arrow (I) direction turns on the unit after one second and the screen as shown below appears.

```
Fostex
DC-R302
```

If an SD card is inserted to the [SD CARD] slot, the unit reads the card and the screen as shown below appears.

```
+ Card Loaded +
+                +
```

If the card contains one or more audio files, the unit reads a file, while the level meter screen as shown below appears.



To turn off the unit, slide the [POWER] switch in the arrow (I) direction and hold it for two seconds.

<Memo>: During playback and recording, you cannot turn on the unit.

Internal realtime clock setting

When you turn on the unit for the first time after purchasing it, the screen as shown below appears.

The year digit flashes and you can set the year value.



1. Set the year value using the [-/DOWN] and [+ /UP] keys.
2. After you set the year value, press the [ENTER] key.
The month digit now flashes and you can set the month value.
3. Set the month value using the [-/DOWN] and [+ /UP] keys, and press the [ENTER] key.
In this manner, you can also set values of other digits.
Each press of the [ENTER] key moves the flashing digit in the following order.
"year -> month -> day -> hour -> minute -> second -> year ->.....".
4. After setting all values, press the [EXIT] key.
The realtime clock setting is completed and the display shows the internal clock time.
5. Press the [EXIT] key again.
The display returns to the normal screen.

● Backup battery for the realtime clock

The unit uses the rechargeable button battery for backing up the internal realtime clock. This battery is charged when the unit is on, while it backs up the internal realtime clock when the unit is off. Therefore, if the unit is not used for a long time, the realtime clock may be reset. (The fully-charged button battery can back up the realtime clock for approximately five months.) In such a case, turn on the unit for some hours to charge the button battery so that it can back up the clock.

You can record audio even if the internal realtime clock is reset, however, the date/time information of the audio file created is not correct.

Basic operations

Input connection and setting

You can connect an external audio source such as a microphone, etc. to each of the three [INPUT] (XLR balanced) connectors.

Each input channel provides the phantom power supply (+48 V) and high pass filter, allowing to use the unit in a variety of circumstances.

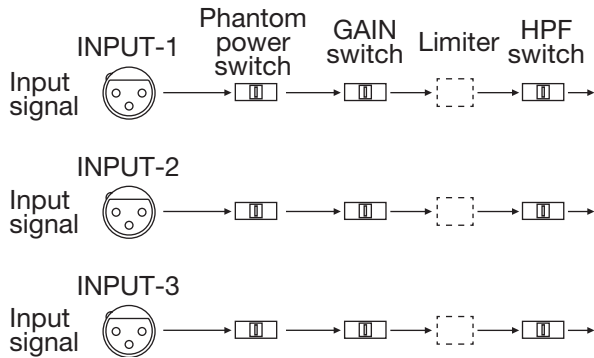

Set the following switches and control for each input channel to match the input source.

● Phantom power switch

If you use a condenser microphone that requires external phantom power, set this switch to “P48”. 48 V power is supplied to both hot (pin 2) and cold (pin 3) pins.

In other conditions, set the switch to “OFF”.

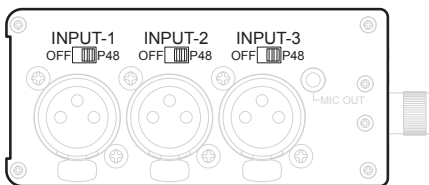

<Memo>: Audio is automatically muted when switching the switch position, so you can change switch setting with the power on.

<Caution>: Do not connect or disconnect a microphone when the switch is set to “P48”. If you do so, a large click noise may be generated.

● [GAIN] switch

This switch selects the gain of the input amplifier. Set the switch according to the volume of an audio source or microphone sensitivity.

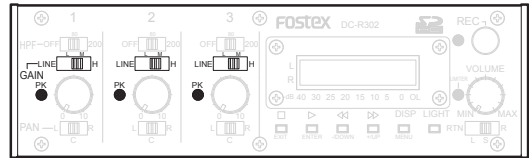

When you connect a line level source, set the switch to “LINE”.

When you connect a microphone, set the switch to “L”, “M” or “H”.

If the [PK] indicator lights in red, the input signal is too high. In this case, place the microphone farther away from the audio source or select the switch to the next left position.

<Memo>: A limiter is provided to the input amplifier section of each channel. When a hot signal is coming in, the limiter automatically reduces the gain to prevent excessive distortion.

● [HPF] switch

When an input signal contains suppressing wind or other low frequency noise, you can remove it using the high pass filter.

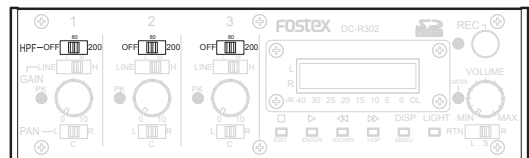

When you do not use the high pass filter, set the [HPF] switch to “OFF”.

To cut ultra-low frequency part, set the switch to “80” to activate the high pass filter with a 80 Hz cutoff frequency (-6 dB/oct rolloff).

To cut the low frequency range significantly, set the switch to “200” to activate the high pass filter with a 200 Hz cutoff frequency (-6 dB/oct rolloff).

Basic operations

Monitoring

<Memo>: The following describes how to monitor audio using headphones. To monitor audio via speakers, use the [OUTPUT] (L and R) connectors on the right side panel. These connectors output the recorder's left and right input signals (or playback signals during playback) at the fixed level.

Connect stereo headphones to the [PHONES] jack on the right side panel.

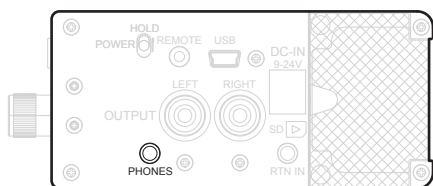

You can adjust the headphone monitor level using the [VOLUME] control on the front panel.

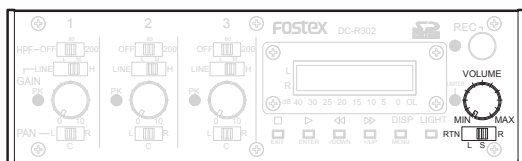

You can also select the headphone monitor source using the headphone monitor source selector below the [VOLUME] control.

Normally, set the selector to the "S" position. With this position, you can monitor the recorder's left and right input signals (or playback signals during playback) in stereo.

By setting the selector to the "L" or "R" position, you can monitor the left or right channel signal of the recorder's stereo signals in mono. You can easily check the left and right recording (or recorded) signals individually.

By setting the selector to the "RTN" position, you can monitor the input signal of the [RTN IN] jack on the right side panel.

Mixer setting

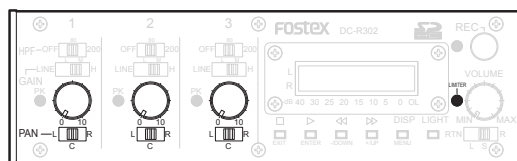

Each input signal is sent to the stereo mix buss and mixed. Then the mixed signals are sent to the recorder as well as output from the [OUTPUT] connectors.

Using the level control, you can adjust the amount of the corresponding input signal sent to the recorder. To record audio without distortion, set the level controls appropriately so that the "OL" (overload) indicators do not light.

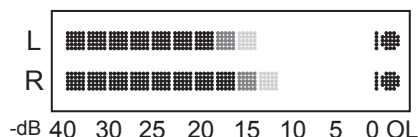

<Memo>: The limiter on the stereo bus automatically works for a sudden excessive hot signal to reduce the level for preventing audio distortion. While the limiter is working, the [LIMITER] indicator lights in yellow.

The [PAN] switch decides the input signal's destination.

When you set the switch to "L", the signal is sent to the left buss and recorded to the left track. In other words, the signal is positioned to the left in stereo.

When you set the switch to "R", the signal is sent to the right buss and recorded to the right track. In other words, the signal is positioned to the right in stereo.

When you set the switch to "C", the signal is sent to both the left and right busses equally and recorded to both the left and right tracks. In other words, the signal is positioned to the center in stereo.

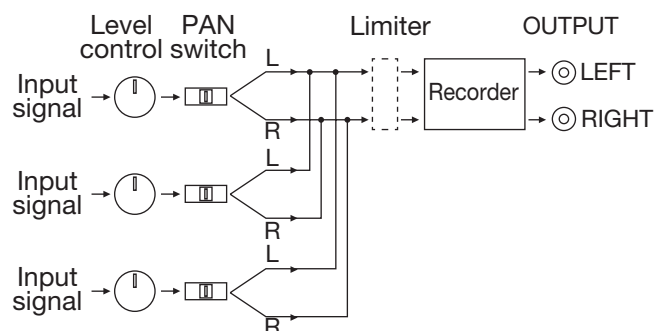

Basic operations

Recording

[Basic recording operations]

When recording is made, a WAV audio file is created on an SD card.

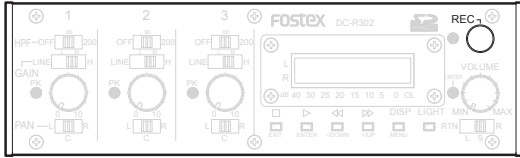

- To start recording, press the [REC] key.
- To stop recording, press the [REC] key again (by default).
After recording stops, the unit closes the audio file.

When you first record a file to an empty SD card, a folder is created and an audio file is created in the folder.

When a folder exists on the SD card, an audio file is created in the current folder.

You can create a new folder or delete an existing folder. See “File management” on page 23 for details.

The maximum audio file size is 2 GB. If the file size exceeds 2 GB during recording, the unit creates a new file and continues recording.

As described in the following, there are a variety of recording-related settings in the menu, such as the recording format (Fs and bit rate combination), record stop key selection, automatically given file name, record start tone, and record stop tone.

[Settings for recording]

You can make the following settings for recording using the menu.

For details about how to make setting for each item, see “Using menu” on page 16.

Recording format

(See also “Selecting recording format” on page 17.)

You can select the combination of the sampling frequency (FS) and bit rate (BIT) from the following.

- 44.1 kHz/16 bit (default)
 - 48 kHz/16 bit
 - 44.1 kHz/24 bit
 - 48 kHz/24 bit
 - 88.2 kHz/24 bit*
 - 96 kHz/24 bit*
- (* Supported from V1.20)

<Memo>: You can mix files with different recording formats on an SD card.

Record stop key

(See also “Selecting the record stop key” on page 18.)

You can select the key to stop recording from the following.

- [REC] key (default)
- [■] key
- Either [REC] or [■] key

Default file name

(See also “Selecting the default file name” on page 19.)

You can select the file name (“default file name”) that is automatically given to an audio file from the following.

- “SCENE + file number” (default)
(Example: “SCENE001.wav”, “SCENE002.wav”)
- “DCR + file number”
(Example: “DCR_001.wav”, “DCR_002.wav”)
- “Year_Month/Day_Hour/Minute_Second”
(Example: “2012_0325_1345_50.wav”)

<Memo>: You cannot edit the file name by the unit. You can transfer a file to a computer and edit the file name by the computer, however, the unit cannot recognize such a file whose filename has been edited.

Basic operations

Recording

Record start tone

(See also “Generating the record start tone” on page 17.)

When you start recording, you can generate a 1 kHz tone twice with a 0.1 second interval.

The tone is recorded to the file as well as output from the [OUTPUT], [MIC OUT] and [PHONES] jacks.

By recording the tone to the audio track of a DSLR when recording video, the tone can be used as reference for start timing adjustment between the DSLR's “video + audio” file and the unit's “audio” file.

By default, the unit does not generate the start tone. When you set the start tone to be generated, you can select the timing of tone generating after recording starts (0 to 3 seconds).

While the tone is being generated (and recorded), the display shows the screen as below.

```
+  TONE REC.  +  
+                +
```

Record end tone

(See also “Generating the record end tone” on page 18.)

When you stop recording, you can generate a 1 kHz tone three times with a 0.1 second interval.

The tone is recorded to the file as well as output from the [OUTPUT], [MIC OUT] and [PHONES] jacks.

By recording the tone to the audio track of a DSLR when recording video, the tone can be used as reference for end timing adjustment between the DSLR's “video + audio” file and the unit's “audio” file.

By default, the unit does not generate the end tone. When you set the end tone to be generated, you can select the timing of tone generating after you press the record stop key (0 to 3 seconds).

While the tone is being generated (and recorded), the display shows the screen as below.

```
+  TONE REC.  +  
+                +
```

Basic operations

Playback

The unit can play back WAV files on an SD card.

[Playable FS/bit combination]

The unit can play back WAV files with following FS/bit combinations (which is same as the combinations the unit can record files with).

44.1 kHz/16 bit
48 kHz/16 bit
44.1 kHz/24 bit
48 kHz/24 bit
88.2 kHz/24 bit
96 kHz/24 bit

[Selecting a file]

You can select a file to be played back by the following procedure.

1. Select a folder in which the desired file is stored.
Pressing the [▶▶] key while holding down the [■] key changes the current folder to the next folder.
Pressing the [◀◀] key while holding down the [■] key changes the current folder to the previous folder.
2. Select the desired file in the folder.
Pressing the [▶▶] key changes the current file to the next file.
Pressing the [◀◀] key changes the current file to the previous file.

<Memo>: If you wish to play back a file from the middle, press and hold the [▶▶] or [◀◀] key while stopped. The unit fast-forwards or rewinds the file at 100 x speed.

[Basic playback operations]

- To start playback:
Press the [▶] key.
The recorder stops after playing back the current file.
- To cue forward or backwards through the file:
Press and hold down the [▶▶] or [◀◀] key during playback.
If you keep holding down the key, the cue speed increases in a stepwise fashion.
- To skip back to the beginning of the current file while playing back in the middle of the file.
Press the [◀◀] key.
- To stop playback:
Press the [■] key.

Outputting audio

The unit outputs a line level (-10 dBV) audio signal to an external device from the [OUTPUT] jacks on the right side panel, while outputs a mic level (-50 dBV) audio signal from the [MIC OUT] jack.

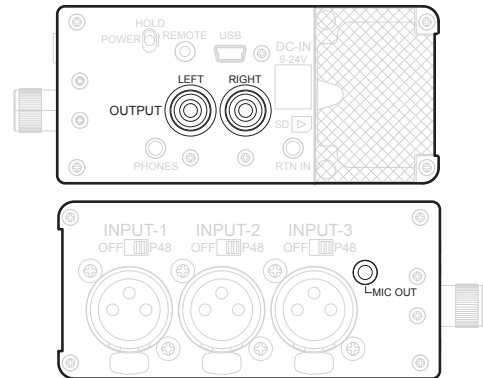

The [OUTPUT] jacks are normally connected to an external mixer, recorder or amplifier. The [MIC OUT] jack is normally connected to the external mic input jack of a DSLR.

The [OUTPUT] jacks output a stereo mix signal while the recorder is in the stop or recording mode, while output a stereo playback signal in the playback mode. The [MIC OUT] jack always outputs a stereo mix signal.

[Outputting a reference tone]

The unit can generate a 1-kHz reference tone and output it to an external device.

1. While holding down the [■] key, press the [LIGHT] key.

The 1-kHz reference tone is output from the [OUTPUT], [MIC OUT] and [PHONES] jacks (at -10 dBV from the [OUTPUT] jacks and at -56 dBV from the [MIC OUT] jack).

2. To stop the reference tone, press the [■] key.

<Memo>: The unit cannot generate the reference tone during recording.

Using menu

You can make a variety of settings using the menu.

Basic menu operations

1. While the recorder is stopped, press and hold the [MENU] key for more than two seconds. The unit enters the menu mode and a menu item is shown on the display.
3. For a menu item that selects the setting, use the [-/DOWN] or [+ /UP] key to select the setting.

```
M> FS/BIT
> 44/16
```

2. Press the [MENU] key to select a desired menu item. Each press of the [MENU] key changes the menu item shown. The long press of the [MENU] key changes the menu item in reverse direction.

4. To exit the menu mode, press the [EXIT] key. The unit returns to the normal mode.

Menu item list

The following menu items are available in the menu.

Menu item	Description	Setting options	Default
FS/BIT	Selects Fs/bit.	44/16, 48/16, 44/24, 48/24, 88/24*, 96/24*	44/16
ToneRec Start	Generates 1kHz tone at record start.	OFF, ON(0s), ON(0.5s), ON(1s), ON(1.5s), ON(2s), ON(3s)	OFF
ToneRec End	Generates 1kHz tone at record end.	OFF, ON(0s), ON(0.5s), ON(1s), ON(1.5s), ON(2s), ON(3s)	OFF
REC STOP KEY	Selects key for stop recording.	REC, REC & STOP, STOP	REC
DEF. FILENAME	Selects "default file name".	SCENE, DC-R_	SCENE
MAX FILE SIZE*	Selects maximum file size.	2G, 4G	2G
AUTO CONT FILE*	"Auto continuous file" mode ON/OFF.	ON, OFF	ON
USB	Selects USB connection mode.	OFF, PC*, AUDIO	OFF
BATTERY	Selects battery type.	ALCALI, Ni-MH	ALCALI
IR REMOTE	Selects infra-red controlled device.	OFF, Canon	OFF
SD FORMAT	Formats SD card.	-	-
RTC	Adjusts internal clock.	-	-
RESET	Initializes menu item settings.	-	-
Version x.xx	Displays current version.	-	-

* Supported from V1.20.

Using menu

Menu item details

● Selecting recording format [FS/BIT]

You can select the sampling frequency (FS) and bit rate (BIT) combination of an audio file to be recorded in the following procedure. The default is “44 kHz/16 bit” (see “Settings for recording” on page 13).

<Memo>: You can mix files with different recording formats on an SD card.

1. While the recorder is stopped, press and hold the [MENU] key for more than two seconds. The unit enters the menu mode and a menu item is shown on the display.
2. Press the [MENU] key as many times as required to select the “FS/BIT” menu item.

```
M> FS/BIT
> 44/16
```

The numeric value at the left side of the slash shows the sampling frequency (kHz), while the value at the right side shows the bit rate (bit).

<Memo>: The long press of the [MENU] key changes the menu item in reverse direction.

3. Use the [-/DOWN] or [+ /UP] key to select the sampling frequency and bit rate combination from the following.

44/16 (default), 48/16, 44/24, 48/24,
88/24, 96/24

The setting is effective immediately.

4. To exit the menu mode, press the [EXIT] key.

● Generating the record start tone [ToneRec Start]

When you start recording, you can generate a 1 kHz tone twice with a 0.1 second interval (see “Record start tone” on page 14). You can select the timing of tone generating after recording starts.

The following shows how to select the record start tone setting.

1. While the recorder is stopped, press and hold the [MENU] key for more than two seconds. The unit enters the menu mode and a menu item is shown on the display.
2. Press the [MENU] key as many times as required to select the “ToneRec Start” menu item.

```
M> ToneRec Start
> OFF
```

<Memo>: The long press of the [MENU] key changes the menu item in reverse direction.

3. Use the [-/DOWN] or [+ /UP] key to select the setting from the following.

- OFF (default): No tone is generated.
- ON (0s): The tone is generated immediately after recording starts.
- ON (0.5s): The tone is generated 0.5 seconds after recording starts.
- ON (1s): The tone is generated 1 second after recording starts.
- ON (1.5s): The tone is generated 1.5 seconds after recording starts.
- ON (2s): The tone is generated 2 seconds after recording starts.
- ON (3s): The tone is generated 3 seconds after recording starts.

The setting is effective immediately.

4. To exit the menu mode, press the [EXIT] key.

Using menu

Menu item details

● Generating the record end tone [ToneRec End]

Before you stop recording, you can generate a 1 kHz tone three times with a 0.1 second interval (see “Record end tone” on page 14). You can select the timing of tone generating after you press the record stop key.

The following shows how to select the record end tone setting.

1. While the recorder is stopped, press and hold the [MENU] key for more than two seconds. The unit enters the menu mode and a menu item is shown on the display.
2. Press the [MENU] key as many times as required to select the “ToneRec End” menu item.

```
M> ToneRec End
> OFF
```

<Memo>: The long press of the [MENU] key changes the menu item in reverse direction.

3. Use the [-/DOWN] or [+/UP] key to select the setting from the following.
 - OFF (default): Immediately after you press the record stop key, the recorder stops without generating the tone.
 - ON (0s): Immediately after you press the record stop key, the unit generates the tone, and then the recorder stops.
 - ON (0.5s): 0.5 seconds after you press the record stop key, the unit generates the tone, and then the recorder stops.
 - ON (1s): One second after you press the record stop key, the unit generates the tone, and then the recorder stops.
 - ON (1.5s): 1.5 seconds after you press the record stop key, the unit generates the tone, and then the recorder stops.
 - ON (2s): 2 seconds after you press the record stop key, the unit generates the tone, and then the recorder stops.
 - ON (3s): 3 seconds after you press the record stop key, the unit generates the tone, and then the recorder stops.

The setting is effective immediately.

4. To exit the menu mode, press the [EXIT] key.

● Selecting the record stop key [REC STOP KEY]

By default, the [REC] key is used to stop recording, however, the [■] key can be used to stop recording by the following procedure (see “Settings for recording” on page 13).

1. While the recorder is stopped, press and hold the [MENU] key for more than two seconds. The unit enters the menu mode and a menu item is shown on the display.
2. Press the [MENU] key as many times as required to select the “REC STOP KEY” menu item.

```
M> REC STOP KEY
> REC
```

<Memo>: The long press of the [MENU] key changes the menu item in reverse direction.

3. Use the [-/DOWN] or [+/UP] key to select the setting from the following.
 - REC (default): The [REC] key is used to stop recording.
 - REC & STOP: The [REC] or [■] key is used to stop recording.
 - STOP: The [■] key is used to stop recording.

The setting is effective immediately.

4. To exit the menu mode, press the [EXIT] key.

Using menu

Menu item details

● Selecting the default file name [DEF. FILENAME]

You can select the file name (“default file name”) that is automatically given to an audio file created by the unit. By default, the file name is “SCENE + file number” (see “Settings for recording” on page 13).

1. While the recorder is stopped, press and hold the [MENU] key for more than two seconds. The unit enters the menu mode and a menu item is shown on the display.
2. Press the [MENU] key as many times as required to select the “DEF. FILENAME” menu item.

```
M> DEF. FILENAME
> SCENE
```

<Memo>: The long press of the [MENU] key changes the menu item in reverse direction.

3. Use the [-/DOWN] or [+/UP] key to select the setting from the following.
 - SCENE: “SCENE + file number” (default)
(Example: “SCENE001.wav”, “SCENE002.wav”)
 - DCR_: “DCR + file number”
(Example: “DCR_001.wav”, “DCR_002.wav”)

The setting is effective immediately.

4. To exit the menu mode, press the [EXIT] key.

● Activating the USB mode [USB]

When you connect the unit to a personal computer, you need to set the unit to the USB mode (see “USB function” on page 25).

1. While the recorder is stopped, press and hold the [MENU] key for more than two seconds. The unit enters the menu mode and a menu item is shown on the display.
2. Press the [MENU] key as many times as required to select the “USB” menu item.

```
M> USB
> OFF
```

<Memo>: The long press of the [MENU] key changes the menu item in reverse direction.

3. Use the [-/DOWN] or [+/UP] key to select the setting from the following.
 - OFF: The USB mode is off (the USB connection is disabled).
 - PC*: The unit is set to the USB PC mode.
(* Supported from V1.20.)
 - AUDIO: The unit is set to the USB audio mode.
4. After selecting “PC” or “AUDIO”, press the [EXIT] key to exit the menu mode. The unit restarts and enters to the USB PC or USB audio mode. For details about the USB PC and USB audio modes, see “USB function” on page 25.

Using menu

Menu item details

● Selecting the battery type [BATTERY]

To display the status and alert regarding battery condition correctly, set the “BATTERY” item in the menu appropriately (see “Display for showing battery status” on page 9).

1. While the recorder is stopped, press and hold the [MENU] key for more than two seconds. The unit enters the menu mode and a menu item is shown on the display.
2. Press the [MENU] key as many times as required to select the “BATTERY” menu item.



```
M> BATTERY
> ALKALI
```

<Memo>: The long press of the [MENU] key changes the menu item in reverse direction.

3. Use the [-/DOWN] or [+ /UP] key to select the battery type according to the batteries set in the unit.

ALKALI: When alkaline batteries are set.
Ni-MH: When Ni-MH batteries are set.

4. To exit the menu mode, press the [EXIT] key.

● Selecting the infrared controlled device [IR REMOTE]

To start or stop DSLR recording in sync with the press of the REC key of the unit using infra-red connection, set the “IR REMOTE” menu item appropriately (see “Starting/stopping DSLR recording in sync with the unit” on page 26).

1. While the recorder is stopped, press and hold the [MENU] key for more than two seconds. The unit enters the menu mode and a menu item is shown on the display.
2. Press the [MENU] key as many times as required to select the “IR REMOTE” menu item.



```
M> IR REMOTE
> OFF
```

<Memo>: The long press of the [MENU] key changes the menu item in reverse direction.

3. Use the [-/DOWN] or [+ /UP] key to select either of the following.
 - OFF: The infrared remote control function is disabled.
 - Canon: The infrared remote control function for a Canon DSLR is enabled.

The setting is effective immediately.

4. To exit the menu mode, press the [EXIT] key.

Using menu

Menu item details

● Formatting an SD card [SD FORMAT]

You can format an SD card by the following procedure.

1. While the recorder is stopped, press and hold the [MENU] key for more than two seconds. The unit enters the menu mode and a menu item is shown on the display.
2. Press the [MENU] key as many times as required to select the "SD FORMAT" menu item.

```
M> SD FORMAT
> [Y]:REC+ENT
```

<Memo>: The long press of the [MENU] key changes the menu item in reverse direction.

3. Press the [REC] and [ENTER] keys simultaneously. The unit formats the SD card. All folders and files on the card are erased.
4. To exit the menu mode, press the [EXIT] key.

● Adjusting the realtime clock [RTC]

You can view and adjust the internal realtime clock by the following procedure.

<Memo>: When you turn on the unit for the first time after purchasing it, the unit enters the realtime clock setup mode described below (see "Internal realtime clock setting" on page 10).

1. While the recorder is stopped, press and hold the [MENU] key for more than two seconds. The unit enters the menu mode and a menu item is shown on the display.

2. Press the [MENU] key as many times as required to select the "RTC" menu item. The time information of the internal realtime clock is shown.

```
M> RTC
> 00h2m50s
```

The realtime clock time (hour/minute/second) is shown.

By pressing the [+ / UP] key, you can see the year/month/day.

```
M> RTC
> 2012y03m29d
```

Pressing the [- / DOWN] key returns to the hour/minute/second.

3. To adjust the realtime clock, press the [ENTER] key.

The unit enters the realtime clock setup mode and the year digit flashes. In this condition, you can edit the year value.

```
M> RTC, SETUP
2012y03m29d
```

4. To change the flashing value, use the [- / DOWN] and [+ / UP] keys.

To move the flashing digit, press the [ENTER] key. Each press of the [ENTER] key moves the flashing digit in the following order.

year -> month -> day -> hour -> minute -> second -> year ->.....

5. After setting all values, press the [EXIT] key.

The display returns to show the current clock time (hour/minute/second), as in step 2 above.

6. To exit the menu mode, press the [EXIT] key again.

Using menu

Menu item details

● Resetting menu items [RESET]

You can reset all the menu items to the initial settings by the following procedure.

1. While the recorder is stopped, press and hold the [MENU] key for more than two seconds. The unit enters the menu mode and a menu item is shown on the display.
2. Press the [MENU] key as many times as required to select the "RESET" menu item.

```
M> RESET
> [Y]:REC+ENT
```

<Memo>: The long press of the [MENU] key changes the menu item in reverse direction.

3. Press the [REC] and [ENTER] keys simultaneously.

All the menu items are reset to the initial settings.

4. To exit the menu mode, press the [EXIT] key.

● Viewing the software version [Version x.xx]

You can view the current software version by the following procedure.

1. While the recorder is stopped, press and hold the [MENU] key for more than two seconds. The unit enters the menu mode and a menu item is shown on the display.
2. Press the [MENU] key as many times as required to select the "Version" menu item.

```
M> Version 1.10
> 2012y03m23d
```

<Memo>: The long press of the [MENU] key changes the menu item in reverse direction.

The upper row shows the current software version number, while the lower row shows the creation date of the software.

3. To exit the menu mode, press the [EXIT] key.

File management

The following describes how to manage audio files on the SD card.

Automatic file management

When the unit records audio, a new WAV file is created on the current folder. The name of the created file is automatically given according to the default file name you select using the menu. When you make recording to a formatted SD card for the first time, a folder named "001FXDCR" is also automatically created.

<Note>: If you edit the name of a WAV file on an SD card using a computer, the unit may not recognize the renamed file because of the limitation of characters the unit can recognize.

Besides the automatic file management functions above, you can create a folder, delete a file, or delete all folders and files.

Creating a new folder

Pressing the [▶▶] key while holding down the [■] key changes the current folder to the next folder. However, if there is no "next" folder, the display shows the screen for creating a new folder.

```
[002] NEW FOLDER  
CREATE: <YES> NO
```

While "YES" is enclosed in parentheses as above, pressing the [ENTER] key creates the new folder, whose folder number is increased by 1.

If you cancel creating the new folder, press the [+ / UP] key to select "NO" and press the [ENTER] key.

<Memo>: If there is an empty folder that does not contain a file, you cannot create a new folder.

<Memo>: You can create up to 100 folders on an SD card.

<Memo>: You can store up to 500 files in a folder. If you create a file when 500 files are stored in the current folder, the file is stored to the newly created folder.

<Memo>: You cannot edit the folder name. If you change the folder name by a computer, the unit cannot recognize the renamed folder.

Deleting a file

By pressing the [DISP] key while holding down the [■] key, the display shows the screen for deleting the current file.

```
[002]  
DELETE: YES <NO>
```

To delete the current file, press the [- / DOWN] key to select "YES" (enclose "YES" in parentheses) and press the [ENTER] key.

If you cancel deleting a file, press the [ENTER] or [EXIT] key while "NO" is selected (as the screen above).

<Memo>: If you delete a file when only one file exists in the current folder, the folder becomes empty. In this condition, you cannot create a new folder.

Deleting all folders and files

By formatting an SD card using the menu, all folders and files are erased (see "Formatting an SD card" on page 21).

To format an SD card, select the "SD FORMAT" menu item in the menu mode, and press the [ENTER] and [REC] keys simultaneously.

Display details

The display of the unit shows various information. In the normal mode, each press of the [DISP] key changes the displayed information in the sequence below.

● In the playback or stop mode:

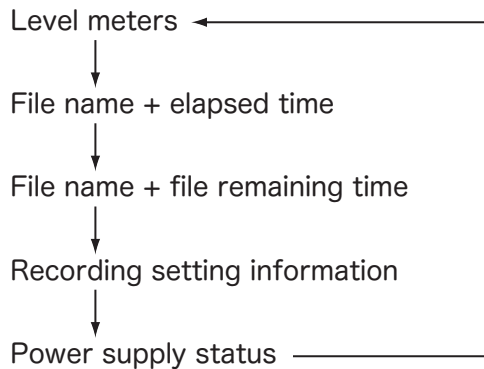

● During recording:

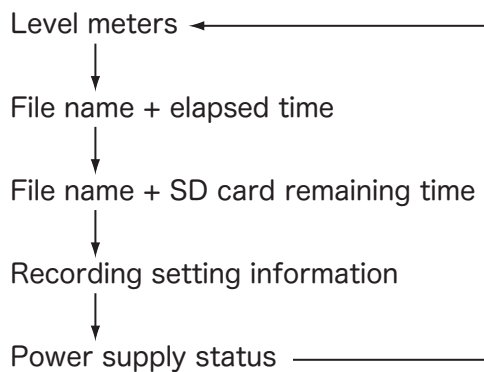

Besides the information above in the normal mode, the display shows various menu screens in the menu mode, as well as alert/error information screens under certain conditions.

For the menu screens, see “Menu item details” on page 17 and the following pages.

For the alert/error information, see “Alert and error screens” on page 28.

The following describes the details of the information screens in the normal mode.

Level meters

After the unit is turned on, the level meters are displayed.

When there is no signal, the display looks like the following.

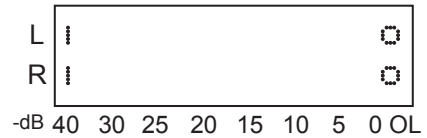

In the stop or recording mode, the level meters show the input signal levels of the recorder's left and right tracks.

In the playback mode, the level meters show the playback levels of the recorder's left and right tracks.

The following shows the example of the meters' behavior when signals are input.

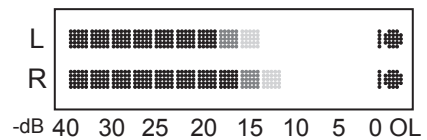

The rightmost “OL” indicator lights when the signal is overloaded.

<Memo>: The highest dot of each meter is retained for about 3 seconds.

File name + elapsed time

```
[001] SCENE008
[ABS] 00h00m08s
```

The upper row shows the current file name.

The lower row shows the elapsed time from the beginning of the file.

File name + remaining time

```
[001] SCENE008
[REM] -00h00m04s
```

The upper row shows the current file name.

The lower row shows the remaining time of the file from the beginning of the file in the playback or stop mode, while it shows the remaining time of the SD card in the recording mode.

Display details

Recording setting information

```
FS/BIT :44/16  
ToneRec :3 /OFF
```

The upper row shows FS (sampling frequency) and BIT (quantization bit).

The lower row shows the settings of tone generation at recording start and stop.

In the screen example above, the record start tone is generated 3 seconds after recording starts, while the record end tone is not generated.

Power supply status

● When the unit is powered by batteries:

```
BATT:■■■■■■■■■■  
VOLT: 4.4/ALKALI
```

The upper row shows the battery remaining. The lower row shows the current battery voltage, as well as the battery type you set in the menu.

● When the unit is powered from an external unit (AC adaptor or external battery pack):

```
DC-IN  
VOLT: 9.5
```

The upper row shows “DC-IN”. The lower row shows the current battery voltage.

USB function

By connecting the unit to a personal computer via USB, you can copy a file on the SD card of the unit to the computer (in the USB PC mode) or use the unit as an audio interface for the computer (in the USB audio mode).

Supported OS

- Windows: XP, Vista, 7
- Mac: OS10.6 or later

You can make USB connection by the following procedure.

1. In the menu mode, select the “USB” menu item and set the USB mode to “PC” or “AUDIO” (see “Activating the USB mode” on page 19).

2. Press the [EXIT] key to exit the menu mode.

The unit restarts and enters the USB mode. The display shows either of the following depending on the mode you selected in the USB menu item.

In the USB PC mode

```
[USB] PC  
: Ready
```

In the USB audio mode

```
[USB] Audio  
: Ready
```

3. Use a USB cable to connect the [USB] connector of the unit to the USB connector of a personal computer.

The USB connection is now established.

● USB PC mode (supported from V1.20)

The SD card in the unit is mounted to the computer.

While the computer is accessing the SD card, the status indicator of the unit flashes in green. When it recognizes the card, the indicator lights in green.

In this mode, you can copy an audio file on the SD card to the computer. You can also play back an audio file on the SD card by the computer.

However, you cannot edit the name of an audio file on the SD card from the computer or copy an audio file from computer to the SD card.

● USB audio mode

The unit acts as an audio interface for a computer. When the computer recognizes the unit, the status indicator lights in orange.

By pressing the [EXIT] key, the display changes to show the level meters.

In this mode, the stereo mix signal of the unit is sent to the computer in realtime, as well as provided to the output connectors of the unit.

By pressing the [REC] key while in the USB audio mode, the status indicator changes to flash in orange, and the unit can receive a USB audio signal sent from the computer and output from the unit's output connectors (except the [MIC OUT] connector). In other words, the unit also acts as a USB DAC.

<Memo>: If you send an audio signal from the unit to the computer and then receive it back using the USB DAC function, the audio is delayed.

Using the unit with a DSLR

The unit provides some useful functions for using the unit with a DSLR (digital single-lens reflex camera) that can record video.

Mounting a DSLR to the unit

You can mount a DSLR to the top panel of the unit by the following procedure.

1. Attach the supplied camera mount bracket to the unit by fixing the two screws of the bracket to the screw holes on the top panel of the unit.



On each of the left and right sides of the bracket, there are three holes for inserting the screw for fixing the bracket to the unit. Depending on which hole you choose, you can adjust the DSLR position back and forth.

<Memo>: At this moment, the DSLR that supports the infrared remote start/stop function described below is the Canon EOS 5D Mark II only. When you mount this model to the unit, set the bracket to the front side.

2. Mount a DSLR to the bracket by fixing the bracket screw to the tripod screw hole of the camera. The bracket screw is movable right and left so you can adjust the DSLR position.

<Memo>: When you use the unit without using a DSLR together, it is recommended to remove the bracket.

Starting/stopping DSLR recording in sync with the unit

When you mount a DSLR that supports the infrared remote control to the top of the unit, you can start and stop the DSLR recording in sync with start and stop of the unit.

When the unit start or stop recording, the infrared signal is sent from the infrared transmitter on the top panel of the unit to the DSLR, causing the DSLR to start or stop recording.

To use the infrared remote control function, you need to set the infrared controlled device correctly by following the procedure below.

[Selecting the infrared controlled device type]

1. While the recorder is stopped, press and hold the [MENU] key for more than two seconds. The unit enters the menu mode and a menu item is shown on the display.
2. Press the [MENU] key as many times as required to select the "IR REMOTE" menu item.

```
M> IR REMOTE
> OFF
```

<Memo>: The long press of the [MENU] key changes the menu item in reverse direction.

3. Use the [-/DOWN] or [+ /UP] key to select either of the following.
 - OFF: The infrared remote control function is disabled.
 - Canon: The infrared remote control function for a Canon DSLR is enabled.

The setting is effective immediately.

4. To exit the menu mode, press the [EXIT] key.

Sending audio to a DSLR

The [MIC OUT] connector outputs the same stereo mix signal as fed to the recorder at -50 dBV mic level.

By connecting the [MIC OUT] connector to the external mic input connector of a DSLR using a stereo mini plug cable, you can record a high quality stereo mix output signal of the unit to the DSLR.

<Memo>: Though the [MIC OUT] connector is a 4-pole mini jack, use a standard stereo (3-pole) mini plug to connect to a DSLR. See "[MIC OUT] connector" on page 7 in "Features and controls" for the pin assignment of the [MIC OUT] connector.

Using camera accessories

Using a tripod

Using either of the three screw holes on the bottom panel, you can mount the unit on a camera tripod.

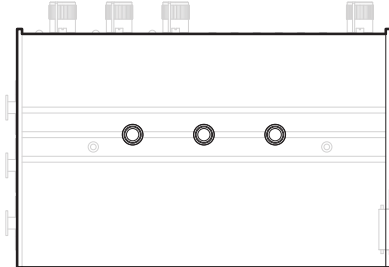

Using a remote shutter release for controlling the unit

By connecting a Panasonic (or equivalent) remote shutter release to the [REMOTE] connector, you can start or stop the unit recording remotely.

The functions of the shutter button and slide switch on a remote shutter release are as follows.

● Shutter button

Half press: Does nothing.

Full press: Starts or stops recording.

● Slide switch

Sliding the switch towards LOCK starts recording. You cannot stop recording by sliding the switch to the opposite direction during recording. To stop recording using the slide switch, slide it to the opposite direction and slide it towards LOCK again.

Alert and error messages

Alert messages

If there is any problem with the unit, an appropriate alert message appears on the display.

<Memo>: Pressing the [MENU] key turns off the alert message, however, it may appear again if the condition is not improved.

● No SD card is set.

```
* No Card *  
* [Clear]:MENU *
```

The status indicator flashes in green.

● The battery voltage is low.

```
* Battery:Low *  
* [Clear]:MENU *
```

The status indicator flashes in green.

● The battery is empty.

```
* Battery:Empty *  
* [Clear]:MENU *
```

A few seconds after this message appears, the unit turns off.

● No recording space is left on the SD card.

```
* Card:Full *  
* * *
```

Error messages

If there is any problem or error with an audio file, SD card, etc., an appropriate error message appears on the display.

● The unit cannot recognize the audio file.

```
* Song:Error *  
* [Clear]:MENU *
```

● The unit cannot recognize the SD card.

```
* Card:Error *  
* [Clear]:MENU *
```

● The SD card is locked.

```
* Card:Locked *  
* [Clear]:MENU *
```

● Recording is missed because audio processing cannot catch up.

```
* Rec:Missed *  
* [Clear]:MENU *
```

Specifications

Analog audio inputs/outputs

(0 dBu=0.775 Vrms, 0 dBV=1 Vrms)

[Inputs]

● [INPUT] connectors (1 through 3)

- Connectors: XLR-3-31 (female, pin 2=hot), electronically balanced
- Input level / impedance (switchable using the [GAIN] switch)

[GAIN] switch position	Nominal input level	Maximum input level	Input impedance
H	-60 dBu	-32 dBu	2 kohms or more
M	-55 dBu	-27 dBu	2 kohms or more
L	-50 dBu	-22 dBu	2 kohms or more
LINE	-10 dBu	+10 dBu	10 kohms or more

● [RTN IN] connector

- Connector: 3.5 mm diameter stereo mini jack, unbalanced
- Nominal input level: -10 dBV
- Maximum input level: +2 dBV
- Input impedance: 10 kohms or more

[Outputs]

● [OUTPUT] connectors (LEFT, RIGHT)

- Connector: RCA jacks, unbalanced
- Nominal output level: -10 dBV (at nominal input level or -12 dBFS signal playback)
- Maximum output level: +2 dBV (at 0 dBFS signal playback)
- Applicable load impedance: 10 kohms or more

● [MIC OUT] connector

- Connector: 3.5 mm diameter 4-pole mini jack
- [Stereo outputs]
- Nominal output level: -50 dBV (at nominal input level)
 - Maximum output level: -30 dBV
 - Applicable load impedance: 10 kohms or more

[Remote]

- Open: 40 kohms / close: 2 kohms

● [PHONES] connector

- Connector: 3.5 mm diameter stereo mini jack
- Applicable load impedance: 8 ohms or more
- Maximum output power: 50 mW + 50 mW (32-ohm load, THD: 0.1 % or less)

Other connectors

● [REMOTE] connector

- Connector: 2.5 mm diameter 4-pole mini jack

● [USB] connector

- Connector: Mini B type

● [DC-IN] connector

- Connector: DC inlet (center positive, 5.5 mm outer diameter x 2.1 mm inner diameter)

Peak limiter

- Attack time: Approx. 0.5 msec
- Release time: Approx. 200 msec
- Threshold: -1 dBFS

HPF (High Pass Filter)

- Cutoff frequency: 80 Hz or 200 Hz switchable
- Slope: -6 dB/oct.

Performance

● Frequency response

- [INPUT] (line input) to [OUTPUT]: 20 Hz to 20,000 kHz +/-1 dB (nominal level)
- [INPUT] (line input) to [MIC OUT]: 20 Hz to 20,000 kHz +/-2 dB (nominal level)
- [INPUT] (mic input) to [OUTPUT]: 40 Hz to 20,000 kHz +/-1 dB (nominal level)
- [PHONES] output: 20 Hz to 20,000 kHz +/-3 dB (32 ohms load, 25 mW output power)

● S/N ratio (LPF: 20 kHz, A-weighted)

- For line level input: 90 dB or more ([GAIN] switch: LINE)
- For mic level input: 55 dB or more ([GAIN] switch: H, input: 150 ohms)

● THD (LPF: 20 kHz)

- For line level input: 0.01 % or less at 1 kHz ([GAIN] switch: LINE)
- For mic level input: 0.1 % or less at 1 kHz ([GAIN] switch: H)

● Crosstalk (adjacent channels)

- For line level input: -70 dB or less at 1 kHz ([GAIN] switch: LINE)
- For mic level input: -70 dB or less at 1 kHz ([GAIN] switch: H)

Specifications

General

- **External dimensions:**

152 (W) x 44* (H) x 97 (D) mm
(excluding protrusions)

*52.5 mm when the bracket is mounted.

- **Weight:**

- Approx. 700 g (including bracket and battery case, excluding batteries)
- Approx. 950 g (including battery case and four AA alkaline batteries)

- **Power requirement:**

- Battery (via internal battery case):
Four AA batteries (alkaline or Ni-MH)
Working voltage: DC 4.8V - 6V
- External power supply (via [DC IN] connector):
AC adaptor (optional)
External battery pack
Working voltage: DC 9V - 24V
Minimum working voltage: 7.2V

- **Power consumption: Approx. 3W**

- **Battery duration time**

Battery type	Phantom power off (for all inputs)	Phantom power on (for all inputs)
Alkaline	Approx. 5.5 hours	Approx. 3 hours
Ni-MH (SANYO eneloop)	Approx. 6 hours	Approx. 4 hours
Ni-MH (SANYO eneloop pro)	Approx. 7.5 hours	Approx. 5 hours

- **Supplied accessories:**

Battery case, Camera mount bracket, Quick start manual

* Specifications and appearance are subject to change without notice for product improvement.

External dimensions

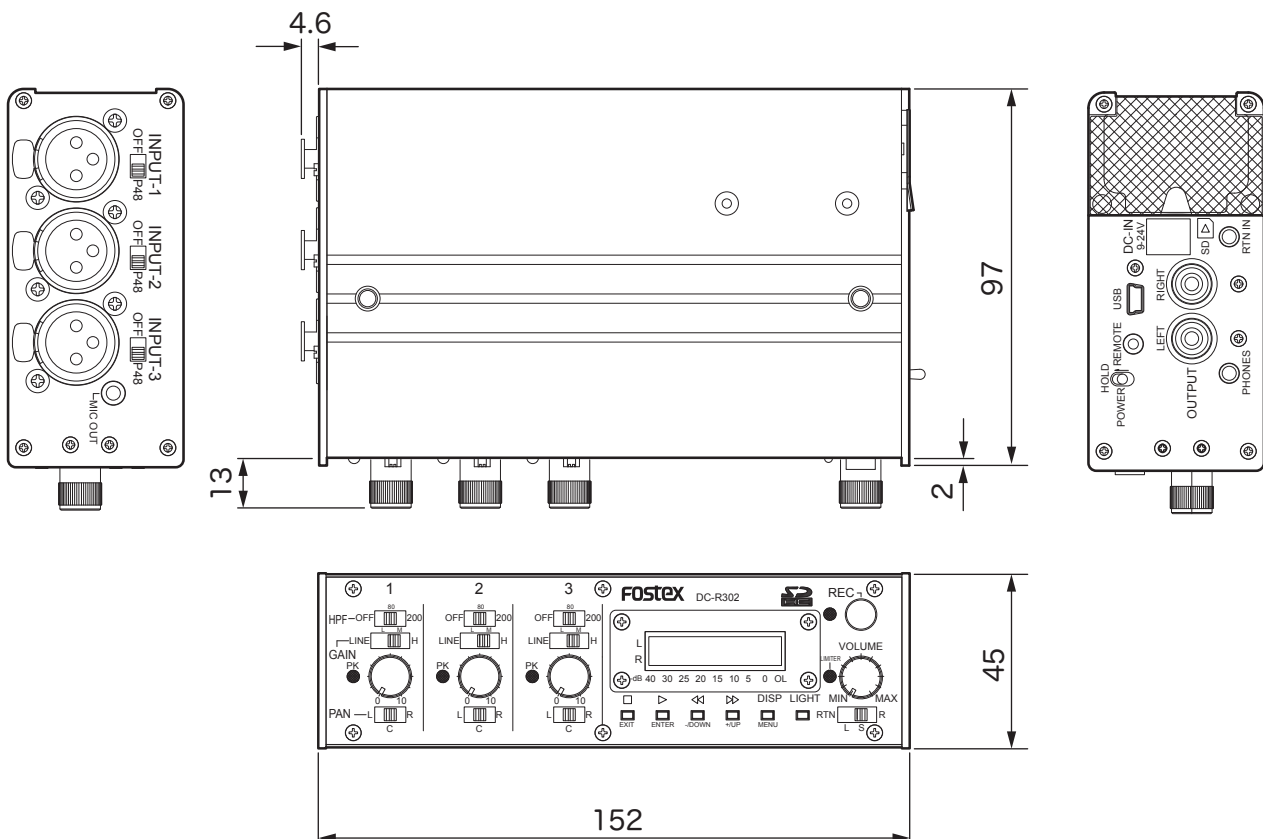

Block diagram

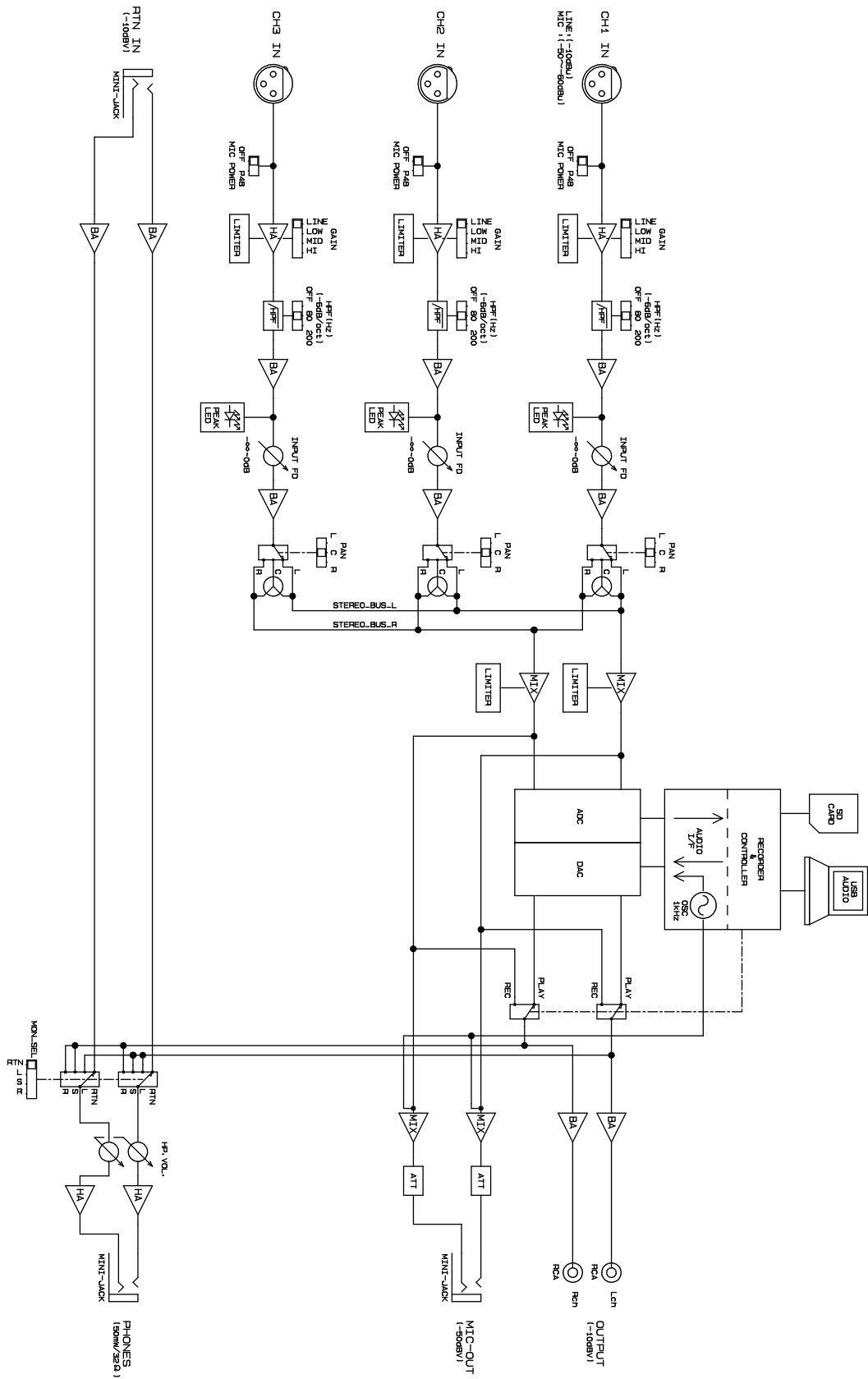

Fostex

FOSTEX CO.

3-2-35 Musashino, Akishima-shi, Tokyo, Japan 196-0021