

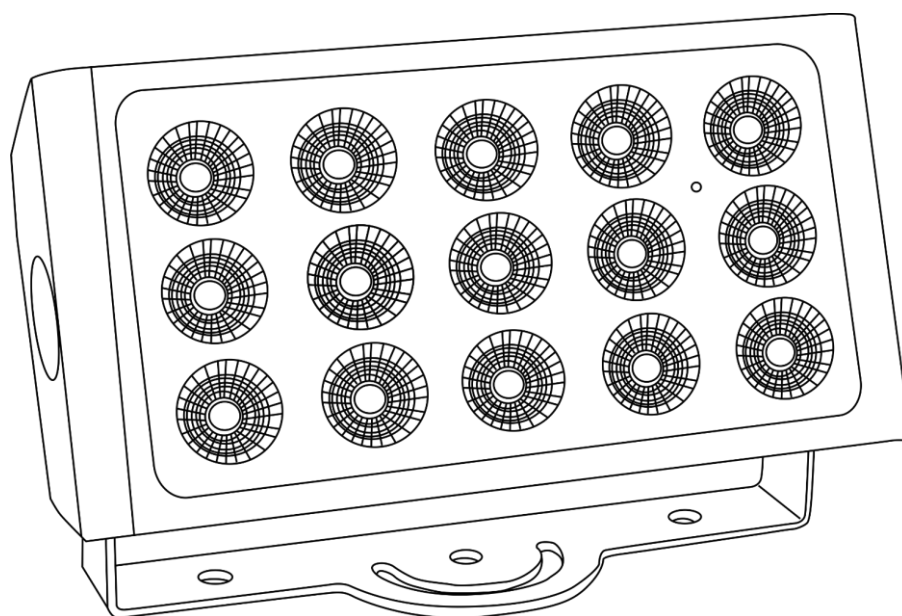

**MANUAL**



**ENGLISH**

**Cameleon Flood 15NW**

**V1**

**Ordercode: 42675**

**Table of contents**

**Warning** ..... 2

    Safety Instructions ..... 2

    Operating Determinations ..... 4

    Rigging ..... 4

    Connection with the mains ..... 5

    Return Procedure ..... 6

    Claims ..... 6

**Description of the device** ..... 7

    Frontside ..... 8

    Backside ..... 8

**Installation** ..... 9

**Set Up and Operation** ..... 9

    Control Modes ..... 9

        One Cameleon Flood (Auto program) ..... 9

        One Cameleon Flood (Manual mode) ..... 9

        Multiple Cameleon Floods (Master/Slave control) ..... 10

        Multiple Cameleon Floods (DMX Control) ..... 11

    Fixture Linking ..... 12

    Data Cabling ..... 12

    Control Panel ..... 13

    Control Mode ..... 13

    DMX Addressing ..... 13

    Menu Overview ..... 14

    Main Menu Options ..... 15

        1. Auto program ..... 15

        2. DMX Address/ DMX Configuration ..... 15

        3. Master/slave ..... 16

        4. Manual mode ..... 16

        5. Settings ..... 16

            5.1. Curves Select ..... 17

            5.2. Dimmer Speed ..... 17

            5.3. Dmx Fail ..... 18

            5.4. Dmx Sync ..... 18

            5.5. Lock ..... 18

            5.6. Factory ..... 19

        6. Information ..... 19

    Optional remote control ..... 20

        Built-in program ..... 20

        Manual mode ..... 20

    DMX Channels ..... 21

        1 DMX Channel ..... 21

        2 DMX Channels ..... 21

**Maintenance** ..... 21

**Troubleshooting** ..... 22

    No Light ..... 22

    No Response to DMX ..... 22

**Product Specifications** ..... 24

**Dimensions** ..... 25

## Warning



**For your own safety, please read this user manual carefully  
before your initial start-up!**



## Unpacking Instructions

Immediately upon receiving this product, carefully unpack the carton and check the contents to ensure that all parts are present, and have been received in good condition. Notify the dealer immediately and retain packing material for inspection if any parts appear damaged from shipping or the carton itself shows signs of mishandling. Save the carton and all packing materials. In the event that a fixture must be returned to the factory, it is important that the fixture be returned in the original factory box and packing.

### Your shipment includes:

- Showtec Cameleon Flood 15NW
- 1x Schuko to 3-pins (IP-65 ) Power cable 1,5m
- User manual

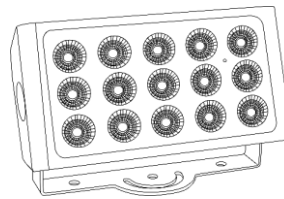

## LED Expected Lifespan

LEDs gradually decline in brightness over time. HEAT is the dominant factor that leads to the acceleration of this decline. Packaged in clusters, LEDs exhibit higher operating temperatures than in ideal or singular optimum conditions. For this reason, when all color LEDs are used at their fullest intensity, life of the LEDs is significantly reduced. If improving the lifespan is of higher priority, place care in providing for lower operational temperatures. This may include climatic-environmental and the reduction of overall projection intensity.



### CAUTION!

**Keep this device away from rain and moisture!  
Unplug mains lead before opening the housing!**



## Safety Instructions

Every person involved with the installation, operation and maintenance of this device has to:

- be qualified
- follow the instructions of this manual



**CAUTION! Be careful with your operations.  
With a dangerous voltage you can suffer  
a dangerous electric shock when touching the wires!**



Before the initial start-up, please make sure that there is no damage caused by transportation. Should there be any, consult your dealer and do not use the device.

To maintain perfect condition and to ensure a safe operation, it is absolutely necessary for the user to follow the safety instructions and warning notes contained in this manual.

Please consider that damages caused by manual modifications to the device are not subject to warranty.

This device contains no user-serviceable parts. Refer servicing to qualified technicians only.

### **IMPORTANT:**

The manufacturer will not accept liability for any resulting damages caused by the non-observance of this manual or any unauthorized modification to the device.

- Never let the power cord come into contact with other cables! Handle the power cord and all connections with the mains with particular caution!
- Never modify, bend, mechanically strain, put pressure on, pull or heat up the power cord.
- Never strain the cable insert or the female part in the device. There must always be sufficient cable going to the device. Otherwise, the cable will be damaged, which can cause serious damage.
- Never remove warning or informative labels from the unit.
- Never use anything to cover the ground contact.
- Never lift the device holding it by the projector-head, as the mechanics may be damaged. Always hold the device by the transport handles.
- Never place any material over the LEDs or lens.
- Never look directly into the light source.
- Never leave any cables lying around.
- Never use the device during thunderstorms, unplug the device immediately.
- Never leave various parts of the packaging (plastic bags, polystyrene foam, nails, etc.) within children's reach, as they are potential sources of danger.
- Do not insert objects into air vents.
- Do not open the device and do not modify the device.
- Do not connect this device to a dimmer pack.
- Do not switch the device on and off in short intervals, as this will reduce the device's life.
- Do not touch the device's housing bare-handed during its operation (housing becomes hot). Allow the device to cool for at least 5 minutes before handling.
- Do not shake the device. Avoid brute force when installing or operating the device.
- Only operate the device after having checked if the housing is firmly closed and all screws are tightly fastened.
- Only operate the device after having familiarized with its functions.
- Avoid flames and do not put close to flammable liquids or gases.
- Always keep the case closed while operating.
- Always allow a free air space of at least 50 cm around the unit for ventilation.
- Always disconnect power from the mains, when device is not used or before cleaning! Only handle the power cord holding it by the plug. Never pull out the plug by tugging the power cord.
- Make sure that the device is not exposed to extreme heat, moisture or dust.
- Make sure that the available voltage is not higher than stated on the rear panel.
- Make sure that the power cord is never crimped or damaged. Check the device and the power cord from time to time.
- Make sure that the core diameter of extension cords and power cords is sufficient for the required power consumption of the device.
- If the lens or LEDs are obviously damaged, they have to be replaced to prevent its functions from being impaired, due to cracks or deep scratches.
- If the external cable is damaged, it has to be replaced by a qualified technician.
- If device was dropped or struck, disconnect mains power supply immediately. Have a qualified engineer inspect for safety before operating.
- If the device has been exposed to drastic temperature fluctuation (e.g. after transportation), do not switch it on immediately. The arising condensation water might damage your device. Leave the device switched off until it has reached room temperature.

- If your Showtec device fails to work properly, discontinue the use immediately. Pack the unit securely (preferably in the original packing material), and return it to your Showtec dealer for service.
- For adult use only. The device must be installed beyond the reach of children. Never leave the unit running unattended.
- Never attempt to bypass the thermostatic switch or fuses.
- For replacement use fuses of same type and rating only.
- The user is responsible for correct positioning and operating of the device. The manufacturer will not accept liability for damages caused by the misuse or incorrect installation of this device.
- This device falls under protection class I. Therefore it is essential to connect the yellow/green conductor to earth.
- Repairs, servicing and electric connection must be carried out by a qualified technician.
- WARRANTY: Till one year after date of purchase.

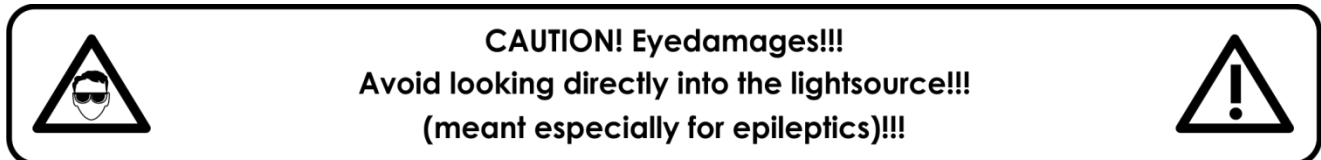

### Operating Determinations

- This device is not designed for permanent operation. Consistent operation breaks will ensure that the device will serve you for a long time without defects.
- The minimum distance between light output and the illuminated surface must be bigger than 1 meter.
- In order to eliminate wear and improve the device's lifespan, during periods of non-use, completely disconnect from power source via breaker or by unplugging.
- The maximum ambient temperature  $t_a = 40^\circ\text{C}$  must never be exceeded.
- The relative humidity must not exceed 50 % with an ambient temperature of  $40^\circ\text{C}$ .
- If this device is operated in any other way than the one described in this manual, the product may suffer damages and the warranty becomes void.
- Any other operation may lead to dangers like short-circuit, burns, electric shock, crash, etc.

*You endanger your own safety and the safety of others!*

### Rigging

*Please follow the European and national guidelines concerning rigging, trussing and all other safety issues.*

*Do not attempt the installation yourself !*

*Always let the installation be carried out by an authorized dealer !*

## Procedure:

- If the Cameleon Flood is lowered from the ceiling or high joists, professional trussing systems have to be used.
- Use a clamp to mount the Cameleon Flood, with the mounting bracket, to the trussing system.
- The Cameleon Flood must never be fixed swinging freely in the room.
- The installation must always be secured with a safety attachment, e.g. an appropriate safety net or safety cable.
- When rigging, derigging or servicing the Cameleon Flood, always make sure, that the area below the installation site is secured and that there are not any unauthorized people around.

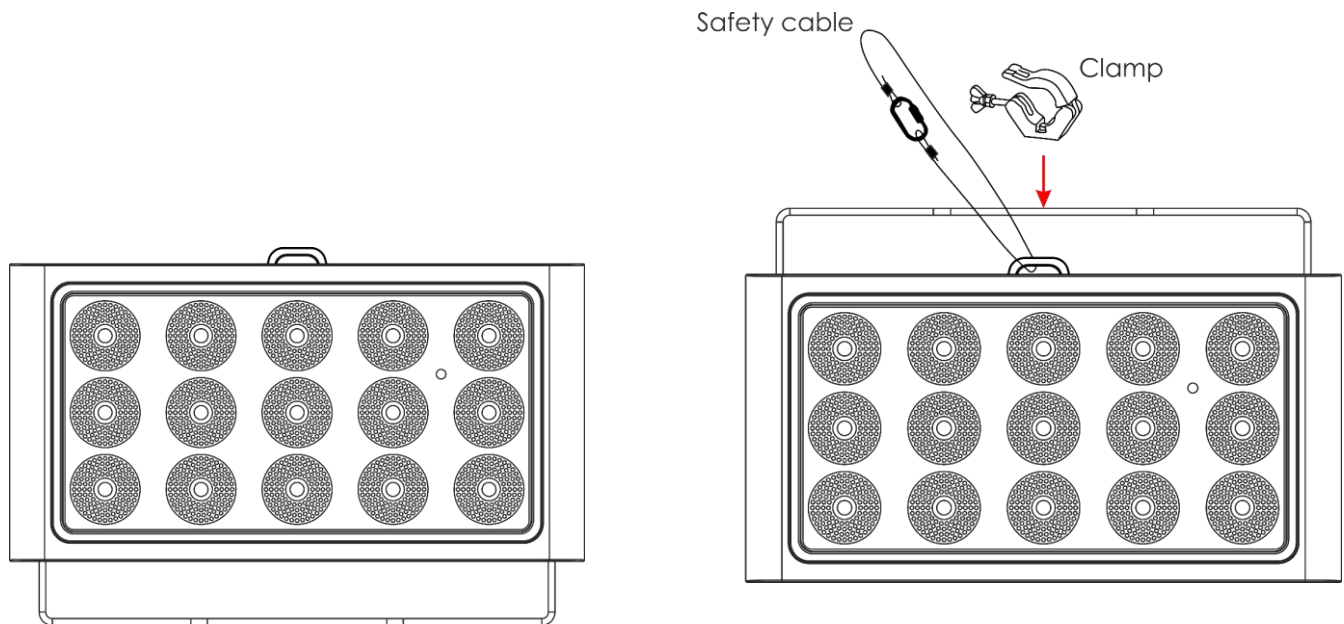

The Cameleon Flood 15NW can be placed on a flat stage floor or mounted to any kind of truss with a clamp.

*Improper installation can cause serious injuries and/or damage of property!*

## Connection with the mains

Connect the device to the mains with the power-plug.

Always check if the right color cable is connected to the right place.

International	EU Cable	UK Cable	US Cable	Pin
L	BROWN	RED	YELLOW/COPPER	PHASE
N	BLUE	BLACK	SILVER	NEUTRAL
⊕	YELLOW/GREEN	GREEN	GREEN	PROTECTIVE GROUND

*Make sure that the device is always properly connected to the earth!*

*Improper installation can cause serious injuries and/or damage of property!*

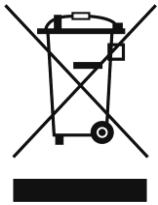

### **Return Procedure**

Returned merchandise must be sent prepaid and in the original packing, call tags will not be issued. Package must be clearly labeled with a Return Authorization Number (RMA number). Products returned without an RMA number will be refused. Highlite will not accept the returned goods or any responsibility. Call Highlite 0031-455667723 or mail [offersales@highlite.com](mailto:offersales@highlite.com) and request an RMA prior to shipping the fixture. Be prepared to provide the model number, serial number and a brief description of the cause for the return. Be sure to properly pack fixture, any shipping damage resulting from inadequate packaging is the customer's responsibility. Highlite reserves the right to use its own discretion to repair or replace product(s). As a suggestion, proper UPS packing or double-boxing is always a safe method to use.

**Note: If you are given an RMA number, please include the following information on a piece of paper inside the box:**

- 01) Your name
- 02) Your address
- 03) Your phone number
- 04) A brief description of the symptoms

### **Claims**

The client has the obligation to check the delivered goods immediately upon delivery for any shortcomings and/or visible defects, or perform this check after our announcement that the goods are at their disposal. Damage incurred in shipping is the responsibility of the shipper; therefore the damage must be reported to the carrier upon receipt of merchandise.

It is the customer's responsibility to report and submit claims with the shipper in the event that a fixture is damaged due to shipping. Transportation damage has to be reported to us within one day after receipt of the delivery.

Any return shipment has to be made post-paid at all times. Return shipments must be accompanied with a letter defining the reason for return shipment. Non-prepaid return shipments will be refused, unless agreed otherwise in writing.

Complaints against us must be prepared in writing or sent by fax within 10 working days after receipt of the invoice. After this period complaints will not be handled anymore.

Complaints will only then be considered if the client has so far complied with all parts of the agreement, regardless of the agreement from which the obligation is resulting.



## Description of the device

---

### Features

The Cameleon Flood 15NW is a wall washer with great output and effects. It is an extension on our Cameleon series. It's an indoor and outdoor solution for illumination of numerous objects.

- Standalone & DMX-512 Control
- Neutral white
- Touch display
- Compact housing
- Powerful output
- XLR 3-pin to mini 3-pin cable ([42708](#)) to connect the Cameleon to DMX, not included!
- Input voltage: 100-240V, 50/60Hz
- Power consumption: 75W @FO
- Drive current: 380mA
- Refresh rate: >1,4 kHz
- CRI: >80
- DMX Mode: 1 or 2 Channels
- Colour temperature: 4000K
- Light source: 15x 8W Power LED (Neutral white)
- Output: 4924 Lumen
- Beam Angle: 39°
- Max. distance: 10m
- Protection rate: IP-65
- Lens Plate: Tempered Glass
- Control: DMX / Auto program / Master-slave/ Manual
- Dimmer: 0-100%
- Strobe: 0-15Hz
- Housing: Die-Cast Black Aluminum
- Cooling: Convection (no fans)
- Connections: Dedicated Power cable IP-65 IN/OUT & Data IP-65 IN/OUT
- Dimensions: 330 x 100 x 210 mm (LxWxH incl. bracket)
- Weight: 5,2 kg

### Optional accessories

[42698](#) Power end cap set Male/female for Cameleon series

[42699](#) Data end cap set Male/female for Cameleon series

[42705](#) Power Extension cable for Cameleon series (3m)

[427056](#) Power Extension cable for Cameleon series (6m)

[42706](#) Power connection cable for Cameleon series (3m)

[42707](#) DMX Extension cable for Cameleon series (3m)

[427076](#) DMX Extension cable for Cameleon series (6m)

[42708](#) DMX Input cable for Cameleon series (3m)

[44002](#) Showtec UR-5 Universal IR Remote



Please make sure to obtain the XLR 3-pin to mini 3-pin cable ([42708](#)) to connect the device to DMX.



## Frontside

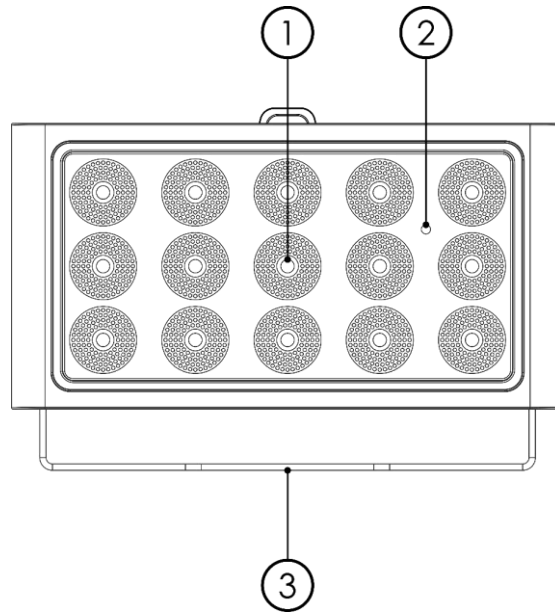

Fig. 01

- 01) 15x 8W Power LED (Neutral white)
- 02) IR sensor
- 03) Mounting bracket

## Backside

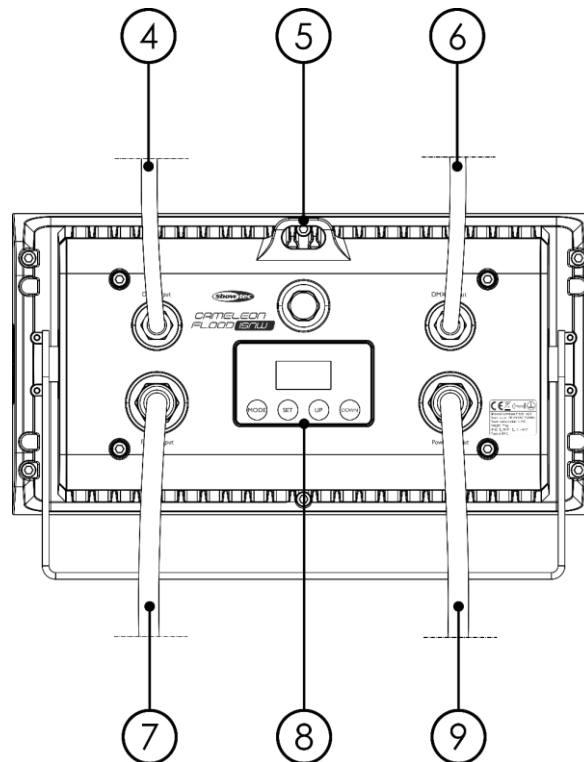

Fig. 02

- 04) Special mini 3-pin DMX cable IN IP-65
- 05) Safety eye
- 06) Special mini 3-pin DMX cable OUT IP-65
- 07) Special mini 3-pin power cable IN IP-65
- 08) OLED Display + control buttons
- 09) Special mini 3-pin power cable OUT IP-65

## Installation

---

Remove all packing materials from the Cameleon Flood 15NW. Check if all foam and plastic padding is removed. Connect all cables.

**Do not supply power before the whole system is set up and connected properly.**

**Always disconnect from electric mains power supply before cleaning or servicing.**

**Damages caused by non-observance are not subject to warranty.**

## Set Up and Operation

---

Follow the directions below, as they pertain to your preferred operation mode.

Before plugging the unit in, always make sure that the power supply matches the product specification voltage. Do not attempt to operate a 120V specification product on 230V power, or vice versa.

### Control Modes

There are 4 modes:

- Auto program
- Manual mode
- Master/slave
- DMX-512 (1CH, 2CH)

#### One Cameleon Flood (Auto program)

- 01) Fasten the effect light onto firm trussing. Leave at least 0,5 meter on all sides for air circulation.
- 02) Always use a safety cable (ordercode 70140 / 70141).
- 03) Plug the end of the electric mains power cord into a proper electric power supply socket.
- 04) When the Cameleon Flood is not connected with a DMX cable, it functions as a stand-alone device. Please see page 15 for more information about the Auto program.

#### One Cameleon Flood (Manual mode)

- 01) Fasten the effect light onto firm trussing. Leave at least 0,5 meter on all sides for air circulation.
- 02) Always use a safety cable (ordercode 70140 / 70141).
- 03) Plug the end of the electric mains power cord into a proper electric power supply socket.
- 04) When the Cameleon Flood is not connected with a DMX cable, it functions as a stand-alone device. Please see page 16 for more information about the Manual mode.

## Multiple Cameleon Floods (Master/Slave control)

- 01) Fasten the effect light onto firm trussing. Leave at least 0,5 meter on all sides for air circulation.
- 02) Always use a safety cable (ordercode 70140 / 70141).
- 03) Use a 3-p XLR cable to connect the Cameleon Floods and other devices.

The pins:



- 01) Earth
- 02) Signal (-)
- 03) Signal (+)

- 04) Link the units as shown in Fig. 03. Connect the first unit's DMX "out" socket with the second unit's "in" socket, using the [42707/427076](#) – DMX Extension cable. Link the second, third and fourth units using the [42707/427076](#) – DMX Extension cable.

You can use the same functions on the master device as described on pages 15 and 16 (Auto program, Manual mode). This means that you can set your desired operation mode on the master device and all slave devices will react the same as the master device.

## Multiple Cameleon Floods (Master/Slave control)

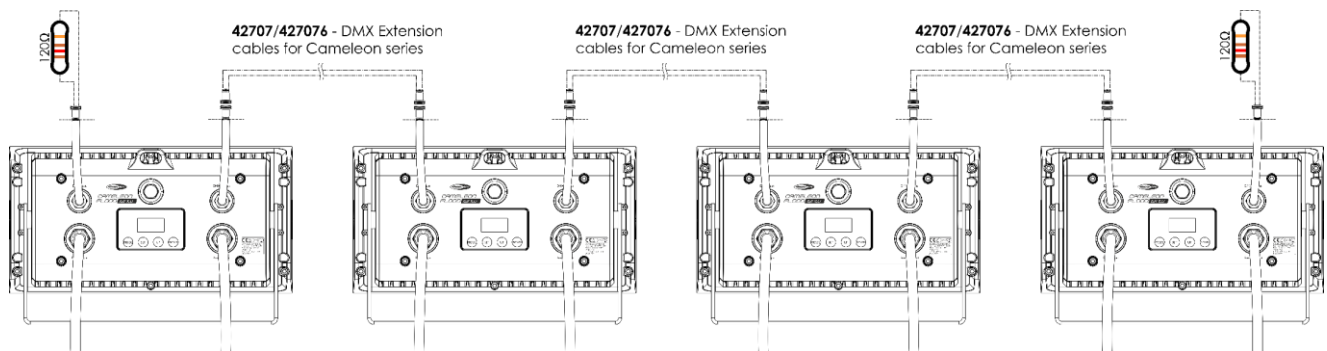
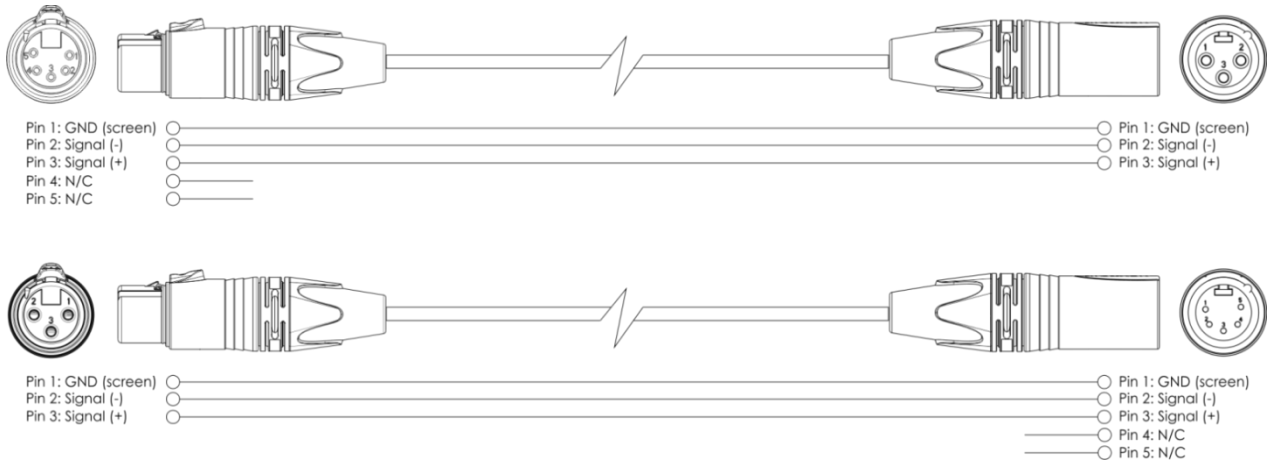

Fig. 03

## Multiple Cameleon Floods (DMX Control)

- 01) Fasten the effect light onto firm trussing. Leave at least 0,5 meter on all sides for air circulation.
- 02) Always use a safety cable (ordercode 70140 / 70141).
- 03) Use a 3-pin XLR cable to connect the Cameleon Floods and other devices.



- 04) Link the units as shown in fig. 04. Connect a light controller to the first unit's DMX "in" socket, using the [42708](#) – DMX input cable. Connect the first unit's "out" socket with the second unit's "in" socket, using the [42707/427076](#)– DMX Extension cable, Link the second and third units using the [42707/427076](#) – DMX Extension cable.
- 05) Supply electric power: Plug electric mains power cords into each unit's special IP65 power IN socket, then plug the other end of the mains power cord into proper electric power supply sockets, starting with the first unit. Do not supply power before the whole system is set up and connected properly.

## Multiple Cameleon Floods DMX Set Up

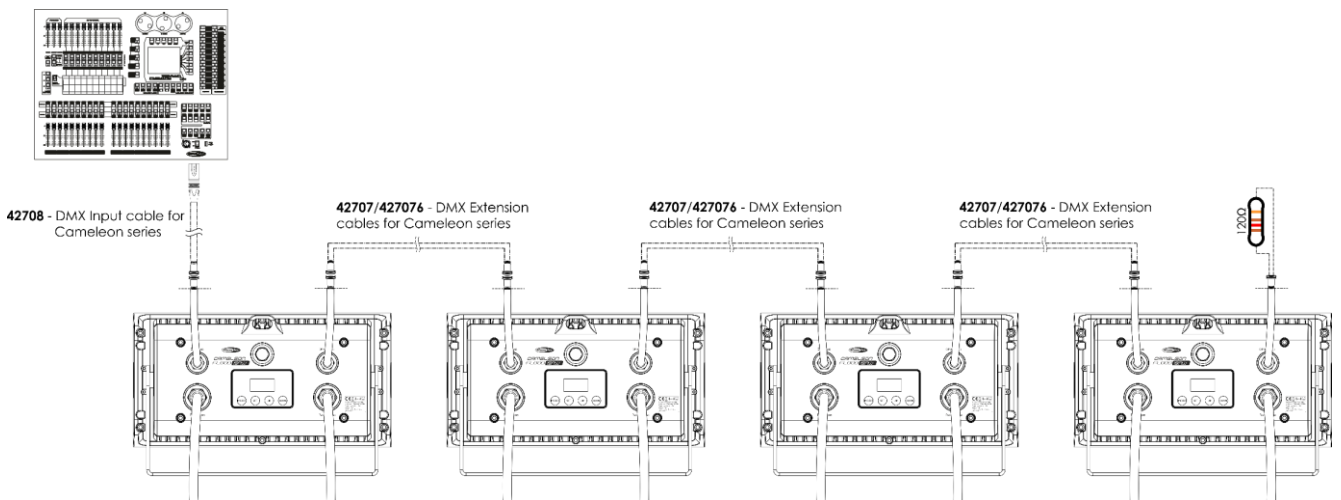

Fig. 04

**Note : Link all cables before connecting electric power**



**Note:** You cannot plug a standard DMX cable directly into the connector. Be sure to use the special cable for DMX connection ([42708](#)) and extension cables ([42707/427076](#)).



## Fixture Linking

You will need a serial data link to run light shows of one or more fixtures using a DMX-512 controller or to run synchronized shows of two or more fixtures set to a master/slave operating mode. The combined number of channels required by all the fixtures on a serial data link determines the number of fixtures the data link can support.

**Important:** Fixtures on a serial data link must be daisy-chained in a single line. To comply with the EIA-485 standard, no more than 30 devices should be connected on one data link. Connecting more than 30 fixtures on one serial data link without the use of a DMX optically isolated splitter may result in deterioration of the digital DMX signal.

Maximum recommended DMX data link distance: 100 meters  
Maximum recommended number of fixtures on a DMX data link: 30 fixtures  
Maximum recommended number of fixtures on a Power link: 12 units @120V  
Maximum recommended number of fixtures on a Power link: 24 units @230V



## Data Cabling

To link fixtures together, you must obtain data cables. You can purchase DAP Audio certified DMX cables directly from a dealer/distributor or construct your own cable. If you choose to create your own cable, please use data-grade cables that can carry a high quality signal and are less prone to electromagnetic interference.

### DAP Audio DMX Data Cables

- DAP Audio Basic microphone cable for allround use. bal. XLR/M 3-pin > XLR/F 3-pin. **Ordercode** FL01150 (1,5 m), FL013 (3 m), FL016 (6 m), FL0110 (10 m), FL0115 (15 m), FL0120 (20 m).
- DAP Audio X-type data cable XLR/M 3-pin > XLR/F 3-pin. **Ordercode** FLX0175 (0,75 m), FLX01150 (1,5 m), FLX013 (3 m), FLX016 (6 m), FLX0110 (10 m).
- DAP Audio cable for the demanding user with exceptional audio-qualities and connector made by Neutrik®. **Ordercode** FL71150 (1,5 m), FL713 (3 m), FL716 (6 m), FL7110 (10 m).
- DAP Audio cable for the demanding user with exceptional audio-qualities and connector made by Neutrik®. **Ordercode** FL7275 (0,75 m), FL72150 (1,5 m), FL723 (3 m), FL726 (6 m), FL7210 (10 m).
- DAP Audio 110 Ohm cable with digital signal transmission. **Ordercode** FL0975 (0,75 m), FL09150 (1,5 m), FL093 (3 m), FL096 (6 m), FL0910 (10 m), FL0915 (15 m), FL0920 (20 m).
- DAP Audio data cable FL08 DMX/AES-EBU, XLR/M 5-pin > XLR/F 5-pin. **Ordercode** FL08150 (1,5 m), FL083 (3 m), FL086 (6 m), FL0810 (10 m), FL0820 (20 m).
- DAP Audio DMX adapter: 5-pin > 3-pin. **Ordercode** FLA29.
- DAP Audio DMX adapter: 3-pin > 5-pin. **Ordercode** FLA30.
- DAP Audio DMX Terminator 3-pin. **Ordercode** FLA42.
- DAP Audio DMX Terminator 5-pin. **Ordercode** FLA43.

**Note:** Use the special DMX cables for DMX connection.

[42707](#) DMX Extension cable for Cameleon series (3m)

[427076](#) DMX Extension cable for Cameleon series (6m)

[42708](#) DMX Input cable for Cameleon series (3m)

The Cameleon Flood 15NW can be operated with a controller in **control mode** or without the controller in **stand-alone mode**.

## Control Panel

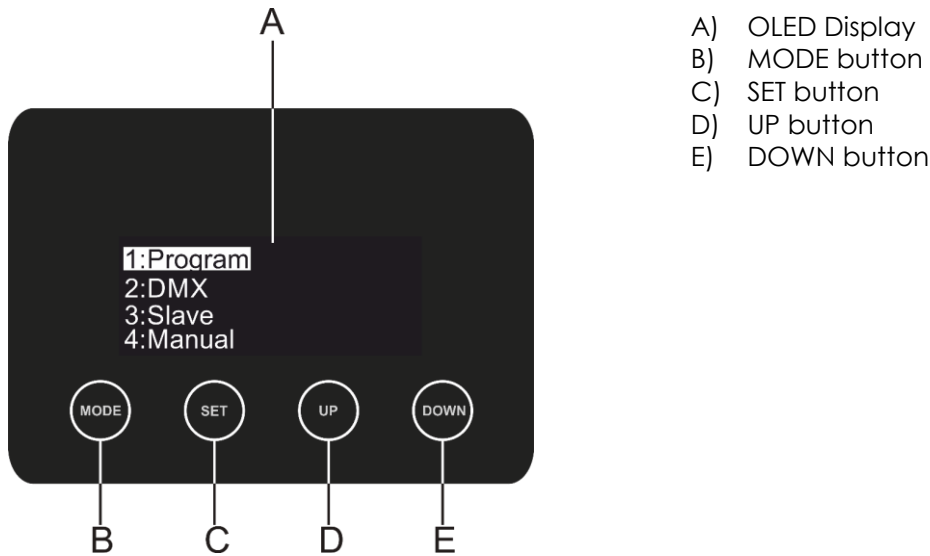

Fig. 05

### Control Mode

The fixtures are individually addressed on a data-link and connected to the controller. The fixtures respond to the DMX signal from the controller. (When you select the DMX address and save it, the controller will display the saved DMX address, next time.)

### DMX Addressing

The control panel on the front side of the base allows you to assign DMX fixture addresses, which is the first channel with which the Cameleon Flood will respond to the controller.

Please note, when you use the controller, the unit has **2** channels.

When using multiple Cameleon Floods, make sure you set the DMX addresses right.

Therefore, the DMX address of the first Cameleon Flood should be **1(001)**; the DMX address of the second Cameleon Flood should be **1+2=3 (003)**; the DMX address of the third Cameleon Flood should be **3+2=5 (005)**, etc. Please, be sure that you do not have any overlapping channels in order to control each Cameleon Flood correctly. If two or more Cameleon Floods are addressed similarly, they will work similarly.

### Controlling:

After having addressed all Cameleon Flood fixtures, you may now start operating these via your lighting controller.

**Note:** After switching on, the Cameleon Flood will automatically detect whether DMX 512 data is received or not. If not, the problem may be:

- The XLR cable from the controller is not connected with the input of the Cameleon Flood.
- The controller is switched off or defective, the cable or connector is defective, or the signal wires are swapped in the input connector.

**Note:** It is necessary to insert an XLR termination plug (with 120 Ohm) in the last fixture in order to ensure proper transmission on the DMX data link.

### Display Off after 60 seconds

When no button is pressed for 60 seconds, the display will turn off.

To light up the display, you have to press the **MODE**, **SET**, **UP** or **DOWN** button.

Once you have pressed the button, the display will light up.

## Menu Overview

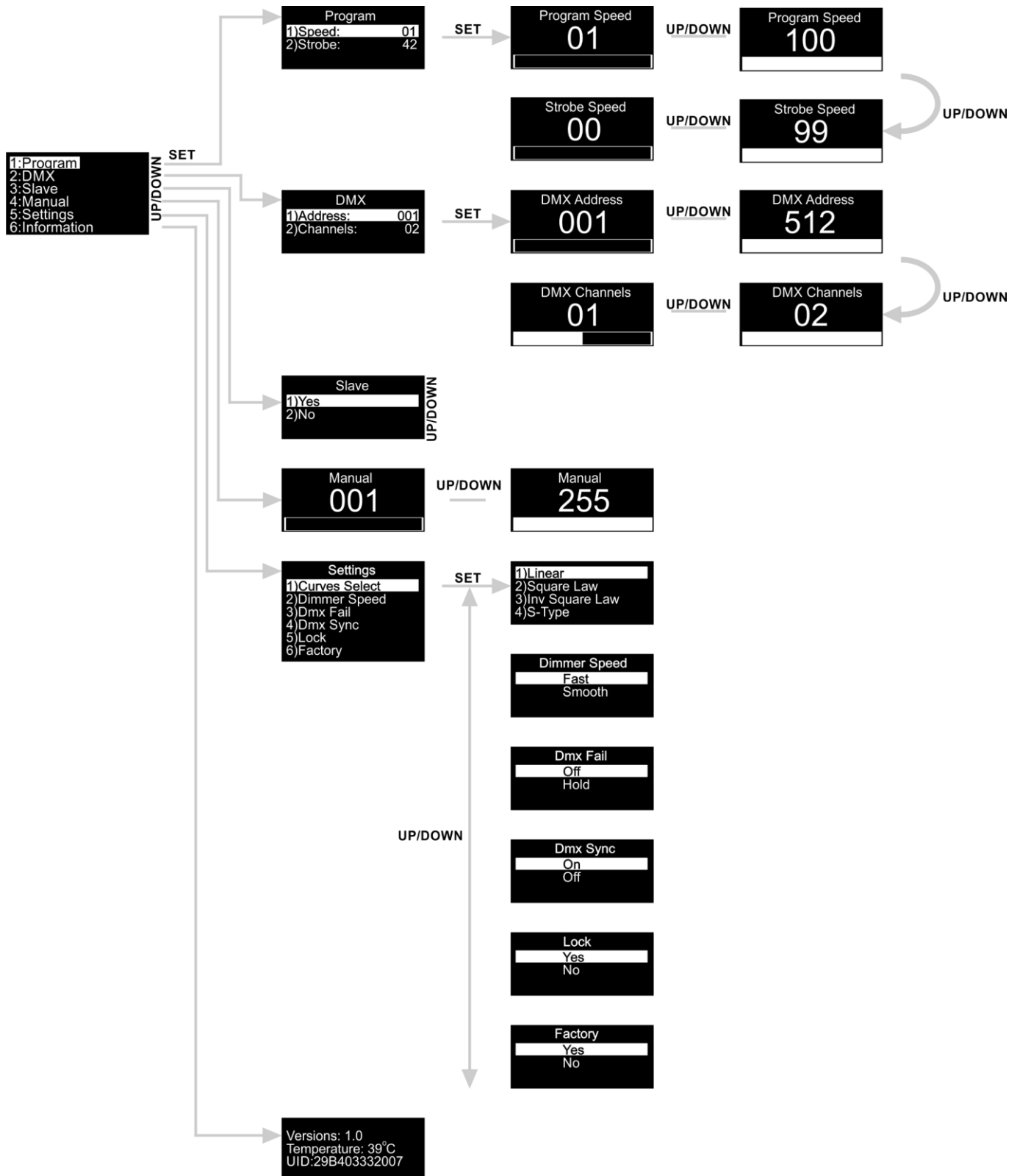

The Cameleon Flood 15NW will show the current software version and actual temperature at start-up !

Versions: 1.0  
Temperature: 39°C



## Main Menu Options

01) Press the **SET** or **MODE** button to open the main menu. The display will show:

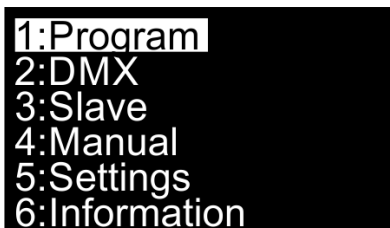





- 02) Press the **UP/DOWN** buttons to toggle between the menus.
- 03) Press the **SET** button to open the desired menu.
- 04) Press the **MODE** button to return to the previous screen.

### 1. Auto program

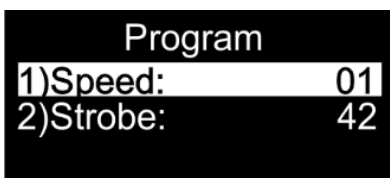
In this menu you can activate the built-in program and set the speed and strobe frequency.

- 01) While in the main menu, press the **UP/DOWN** buttons until the display shows **Program**.
- 02) Press the **SET** button to open the menu, the display will show:







- 03) Press the **UP/DOWN** buttons to choose between Speed or Strobe.
- 04) If you choose **Speed**, press the **SET** button to open the submenu.
- 05) Press the **UP/DOWN** buttons to set the speed. The adjustment range is between  **UP/DOWN** , from slow to fast.
- 06) If you choose **Strobe**, press the **SET** button to open the submenu.
- 07) Press the **UP/DOWN** buttons to increase/decrease the strobe frequency. The adjustment range is between  **UP/DOWN** , from OFF to high strobe frequency.

### 2. DMX Address/ DMX Configuration

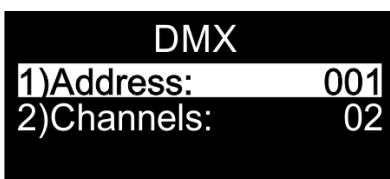
In this menu you can set the device's DMX starting address and choose a DMX configuration.

- 01) While in the main menu, press the **UP/DOWN** buttons until the display shows **DMX**.
- 02) Press the **SET** button to open the menu, the display will show:



- 03) Press the **UP/DOWN** buttons to choose between Address or Channels.
- 04) If you choose **Address**, press the **SET** button to open the submenu.
- 05) Press the **UP/DOWN** buttons to set the desired DMX address.
- 06) The adjustment range is between  **UP/DOWN** .
- 07) If you choose **Channels**, press the **SET** button to open the submenu.
- 08) Press the **UP/DOWN** buttons to choose between  **UP/DOWN** .
- 09) Press the **SET** button to confirm your choice.

### 3. Master/slave

In this menu you can set the device as a slave.

- 01) While in the main menu, press the **UP/DOWN** buttons until the display shows **Slave**.
- 02) Press the **SET** button to open the menu, the display will show:



- 03) Press the **UP/DOWN** buttons to choose between **Yes** or **No**.
- 04) If you choose **Yes**, the device will become a slave.
- 05) All slave devices will follow the master movement. If the device has been set to slave, it will react the same as its master device.
- 06) If the device has not been set to slave (**No**), it is automatically classified as a master device.
- 07) Press the **SET** button to confirm your choice.

### 4. Manual mode

In this menu you can set the light intensity of the device.

- 01) While in main menu, press the **UP/DOWN** buttons until the display shows **Manual**.
- 02) Press the **SET** button to open the menu.
- 03) Press the **UP/DOWN** buttons to set the intensity. The adjustment range is between



- 04) Press the **SET** button to confirm your choice.

### 5. Settings

In this menu you can set several settings of the device.

- 01) While in the main menu, press the **UP/DOWN** buttons until the display shows **Settings**.
- 02) Press the **SET** button to open the menu, the display will show:

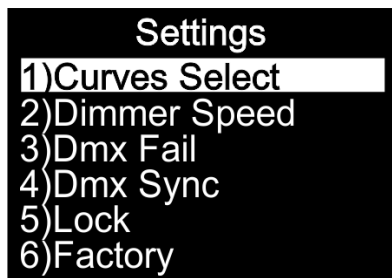

- 03) Press the **UP/DOWN** buttons to toggle between the following menus: Curves Select, Dimmer Speed, Dmx Fail, Dmx Sync, Lock and Factory.

## 5.1. Curves Select

In this menu you can adjust the dimming of the device by choosing a dimming curve.

- 01) Press the **UP/DOWN** buttons to choose Curves Select.
- 02) Press the **SET** button to open the menu.
- 03) Press the **UP/DOWN** buttons to choose the desired dimming curve out of the 4 available options:

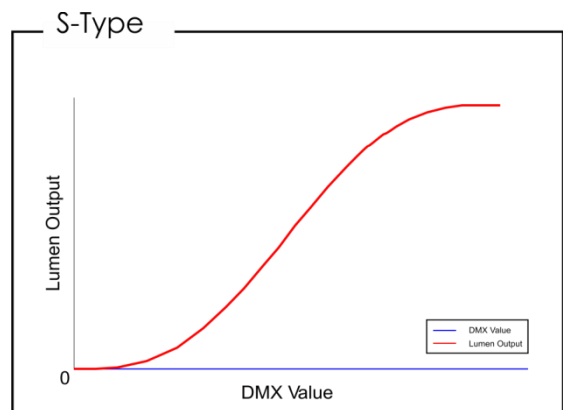
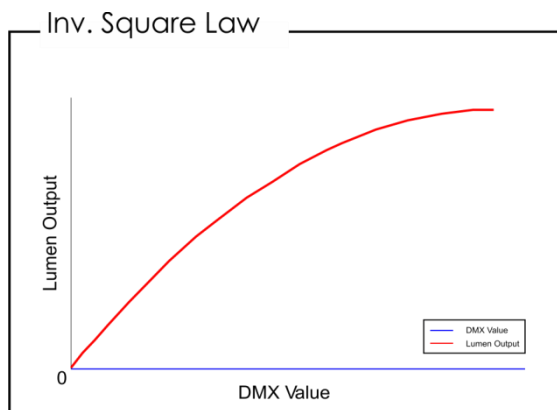
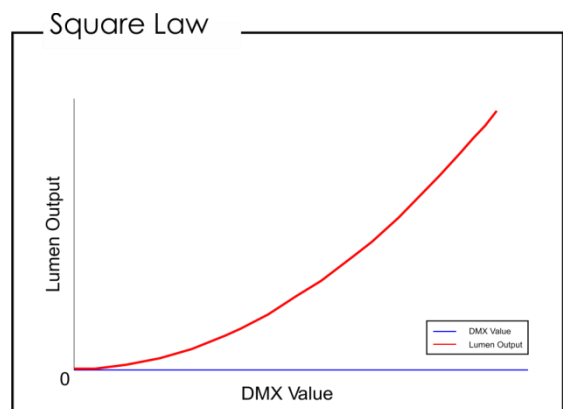
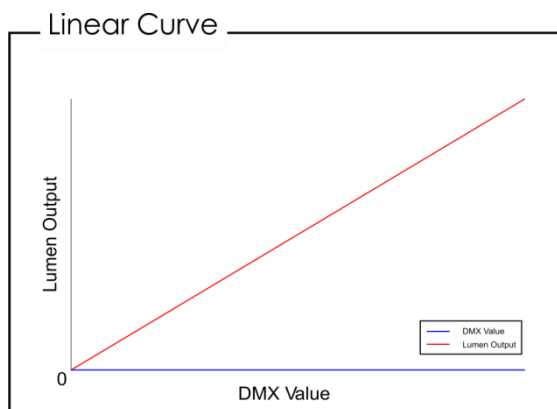

- 04) Press the **SET** button to confirm your choice.

## 5.2. Dimmer Speed

In this menu you can adjust the dimming speed of the device.

- 01) Press the **UP/DOWN** buttons to choose Dimmer Speed.
- 02) Press the **SET** button to open the menu, the display will show:



- 03) Press the **UP/DOWN** buttons to choose between **Fast** or **Smooth**.
- 04) Press the **SET** button to confirm your choice.

## 5.3. Dmx Fail

In this menu you can adjust the behaviour of the device in case of a DMX signal error.

- 01) Press the **UP/DOWN** buttons until the display shows **Dmx Fail**.
- 02) Press the **SET** button to open the menu, the display will show:



- 03) Press the **UP/DOWN** buttons to choose the desired option.
- 04) You can choose between **Off** and **Hold**.
- 05) If you have chosen **Off**, the output will blackout when a DMX signal error occurs.
- 06) If you have chosen **Hold**, the device will fall back on the last properly working DMX signal from before the DMX signal error, which ensures uninterrupted performance.
- 07) Press the **SET** button to confirm your choice.

## 5.4. Dmx Sync

In this menu you can set the DMX synchronisation of the device.

- 01) Press the **UP/DOWN** buttons until the display shows **Dmx Sync**.
- 02) Press the **SET** button to open the menu, the display will show:

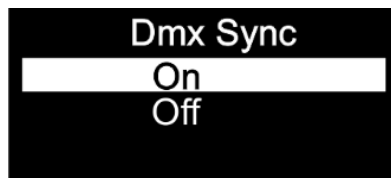

- 03) Press the **UP/DOWN** buttons to select **On** or **Off**.
- 04) The Sync option is a tool which helps to keep multiple fixtures synchronized, when using them in master slave mode.
- 05) If you choose **On**, the synchronization function is activated, this is recommended.
- 06) If you choose **Off**, the synchronization function is not activated.
- 07) Press the **SET** button to confirm your choice.

## 5.5. Lock

In this menu you can select whether the safety lock is active.

- 01) Press the **UP/DOWN** buttons until the display shows **Lock**.
- 02) Press the **SET** button to open the menu, the display will show:

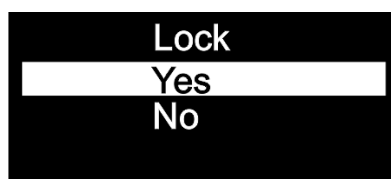

- 03) Press the **UP/DOWN** buttons to select **Yes** or **No**.
- 04) If you have chosen **Yes** and confirm it with the **SET** button, after 35 seconds the device will be in Lock mode. You will need to insert the password in order to access the main menu. Simultaneously press the **MODE** and **SET** button for 3 seconds and you will be able to access the main menu.
- 05) If you choose **No**, the main menu will remain unlocked.
- 06) Press the **SET** button to confirm your choice.

### 5.6. Factory

In this menu you can reset to the factory default settings.

- 01) While in Settings menu, press the **UP/DOWN** buttons to choose **Factory**.
- 02) Press the **SET** button to open the menu, the display will show:

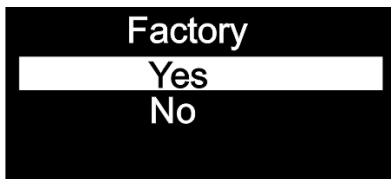

- 03) Press the **UP/DOWN** buttons to select **Yes** or **No**.
- 04) If you choose **Yes** and confirm it with the **SET** button, the device will be reset to its factory default settings.
- 05) If you choose **No**, the device will keep current settings.

### 6. Information

In this menu you can view several info from the device.

- 01) While in main menu, press the **UP/DOWN** buttons to choose Information.
- 02) Press the **SET** button to open the menu.

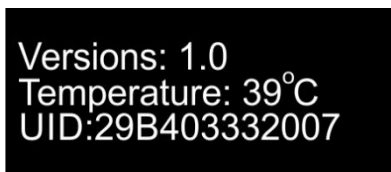

- 03) You can now view the currently installed software version, actual temperature and device code.

## Optional remote control

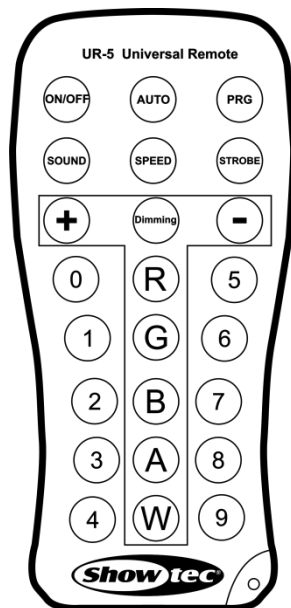

Button	Function	Description
	On / Off	Switch the device ON or OFF
	Program	Activates the Built-in program
	Speed	Activates the Program speed mode
	Strobe	Activates the Strobe frequency mode
	Dimming	Activates the Manual mode
	Plus	Increase button
	Minus	Decrease button

**Note:** Please make sure you activate the program mode in the main menu in order to control the device with the remote control.

### Built-in program

- 01) Press the button to activate the Built-in program mode.
- 02) Press the button to set the program speed.
- 03) Press the and buttons to increase/decrease the program speed. The adjustment range is between 01-100.
- 04) Press the button to set the strobe frequency.
- 05) Press the and buttons to increase/decrease the strobe frequency. The adjustment range is between 0-15Hz, from OFF to high strobe frequency.

### Manual mode

- 01) Press the button to activate the manual mode.
- 02) Press the and buttons to set the intensity of the Cameleon Flood between 0-255.

## DMX Channels

### 1 DMX Channel

#### Channel 1 – Dimmer intensity

0-255      Gradual adjustment, from dark to brightest 0-100%

---

### 2 DMX Channels

#### Channel 1 – Master Dimmer intensity

0-255      Gradual adjustment, from dark to brightest 0-100%

---

#### Channel 2 – Linear strobe (CH1 must be set between 1-255 )

0-10      Closed

11-255      Strobe flash frequency, from slow to fast (0-15 Hz)

---

## Maintenance

---

The operator has to make sure that safety-related and machine-technical installations are to be inspected by an expert after every year in the course of an acceptance test.

The operator has to make sure that safety-related and machine-technical installations are to be inspected by a skilled person once a year.

The following points have to be considered during the inspection:

- 01) All screws used for installing the device or parts of the device have to be tightly connected and must not be corroded.
- 02) There may not be any deformations on housings, fixations and installation spots.
- 03) Mechanically moving parts like axles, eyes and others may not show any traces of wearing.
- 04) The electric power supply cables must not show any damages or material fatigue.

The Cameleon Flood 15NW requires almost no maintenance. However, you should keep the unit clean. Otherwise, the fixture's light-output will be significantly reduced. Disconnect the mains power supply, and then wipe the cover with a damp cloth. Do not immerse in liquid. Wipe lens clean with glass cleaner and a soft cloth. Do not use alcohol or solvents.

The front lens will require weekly cleaning, as smoke-fluid tends to build up residues, reducing the light-output very quickly.

Keep connections clean. Make sure connections are thoroughly dry before linking equipment or supplying electric power.



## Troubleshooting

---

This troubleshooting guide is meant to help solve simple problems.

If a problem occurs, carry out the steps below in sequence until a solution is found. Once the unit operates properly, do not carry out following steps.

### No Light

If the light effect does not operate properly, refer servicing to a technician.

Suspect three potential problem areas as: the power supply, the LEDs, the internal fuse.

- 01) Power supply. Check that the unit is plugged into an appropriate power supply.
- 02) The LEDs. Return the Cameleon Flood to your Showtec dealer.
- 03) The internal fuse. Return the Cameleon Flood to your Showtec dealer.
- 04) If all of the above appears to be O.K., plug the unit in again.
- 05) If you are unable to determine the cause of the problem, do not open the Cameleon Flood, as this may damage the unit and the warranty will become void.
- 06) Return the device to your Showtec dealer.

### No Response to DMX

Suspect the DMX cable or connectors, a controller malfunction, a light effect DMX card malfunction.

- 01) Check the DMX setting. Make sure that DMX addresses are correct.
- 02) Check the DMX cable: Unplug the unit; change the DMX cable; then reconnect to electrical power. Try your DMX control again.
- 03) Determine whether the controller or light effect is at fault. Does the controller operate properly with other DMX products? If not, take the controller in for repair. If so, take the DMX cable and the light effect to a qualified technician.

Problem	Probable cause(s)	Solution
One or more fixtures do not function at all	No power to the fixture	<ul style="list-style-type: none"> <li>• Check if power is switched on and cables are plugged in</li> </ul>
	Internal fuse blown	<ul style="list-style-type: none"> <li>• Return the Cameleon Flood to your Showtec dealer</li> </ul>
Fixtures reset correctly, but all respond erratically or not at all to the controller	The controller is not connected	<ul style="list-style-type: none"> <li>• Connect controller</li> </ul>
	3-pin XLR Out of the controller does not match XLR Out of the first fixture on the link (i.e. signal is reversed)	<ul style="list-style-type: none"> <li>• Install a phase reversing cable between the controller and the first fixture on the link</li> </ul>
Fixtures reset correctly, but some respond erratically or not at all to the controller	Poor data quality	<ul style="list-style-type: none"> <li>• Check data quality. If much lower than 100 percent, the problem may be a bad data link connection, poor quality or broken cables, missing termination plug, or a defective fixture disturbing the link</li> </ul>
	Bad data link connection	<ul style="list-style-type: none"> <li>• Inspect connections and cables. Correct poor connections. Repair or replace damaged cables</li> </ul>
	Data link not terminated with 120 Ohm termination plug	<ul style="list-style-type: none"> <li>• Insert termination plug in output jack of the last fixture on the link</li> </ul>
	Incorrect addressing of the fixtures	<ul style="list-style-type: none"> <li>• Check address setting</li> </ul>
	One of the fixtures is defective and disturbs data transmission on the link	<ul style="list-style-type: none"> <li>• Bypass one fixture at a time until normal operation is restored: unplug both connectors and connect them directly together.</li> <li>• Have the defective fixture serviced by a qualified technician</li> </ul>
	3-pin XLR Out on the fixtures does not match (pins 2 and 3 reversed)	<ul style="list-style-type: none"> <li>• Install a phase-reversing cable between the fixtures or swap pin 2 and 3 in the fixture that behaves erratically</li> </ul>
No light or LEDs cuts out intermittently	Fixture is too hot	<ul style="list-style-type: none"> <li>• Allow the fixture to cool down</li> <li>• Clean the fan</li> <li>• Make sure air vents in control panel and the front lens are not blocked</li> <li>• Turn up the air conditioning</li> </ul>
	LEDs damaged	<ul style="list-style-type: none"> <li>• Disconnect the fixture and return it to your dealer</li> </ul>
	The power supply settings do not match local AC voltage and frequency	<ul style="list-style-type: none"> <li>• Disconnect fixture. Check settings and correct if necessary</li> </ul>

## Product Specifications

Model:	Showtec Cameleon Flood 15NW
Input Voltage:	100-240 VAC, 50/60Hz
Power consumption:	75W @FO
Data linking:	30 pcss
Drive current:	380mA
Refresh rate:	1,4 kHz
Protection rate:	IP-65
Dimensions:	330 x 100 x 210 mm (LxWxH incl. bracket)
Weight:	5,2 kg
<b>Operating and Programming:</b>	
Signal pin OUT:	Pin 1 (earth), pin 2 (-), pin 3 (+)
DMX Mode:	1 or 2 Channels
Signal input:	3-pin DMX IN IP65
Signal output:	3-pin DMX OUT IP65
<b>Electro-mechanical effects:</b>	
Light source:	15 x 8W Power LED (Neutral white)
Output:	4924 Lumen
Beam angle:	39°
Max. distance:	10m
Colour temperature:	4000K
CRI:	>80
Lens Plate:	Tempered Glass
Connections:	Dedicated Power cable IP-65 IN/OUT & Data IP-65 IN/OUT
Dimmer:	0-100%
Strobe:	0-15Hz
Control:	DMX / Auto program / Master-slave/ Manual
Cooling:	Convection (no fans)
Housing	Die-cast Black Aluminium
Max. ambient temperature $t_a$ :	40°C
Max. housing temperature $t_B$ :	80°C
<b>Minimum distance:</b>	
Minimum distance from flammable surfaces:	0,5 m
Minimum distance to lighted object:	1 m

Design and product specifications are subject to change without prior notice.



Website: [www.Showtec.info](http://www.Showtec.info)

Email: [service@highlite.com](mailto:service@highlite.com)

## Dimensions

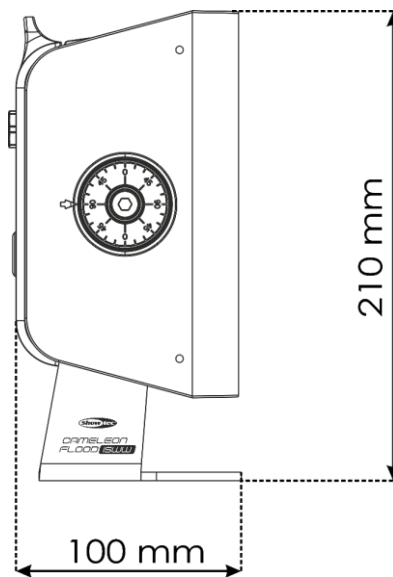
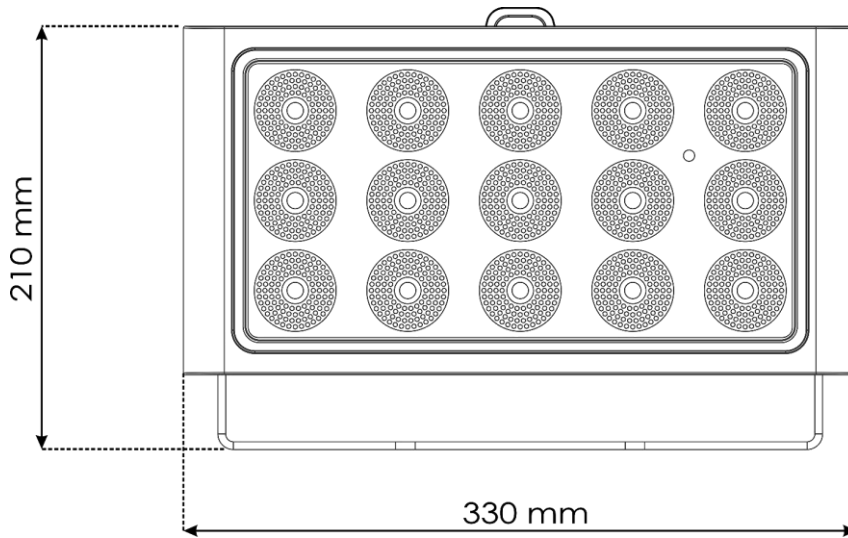





©2018 Showtec