

CLUB

128/512

USB to DMX interface

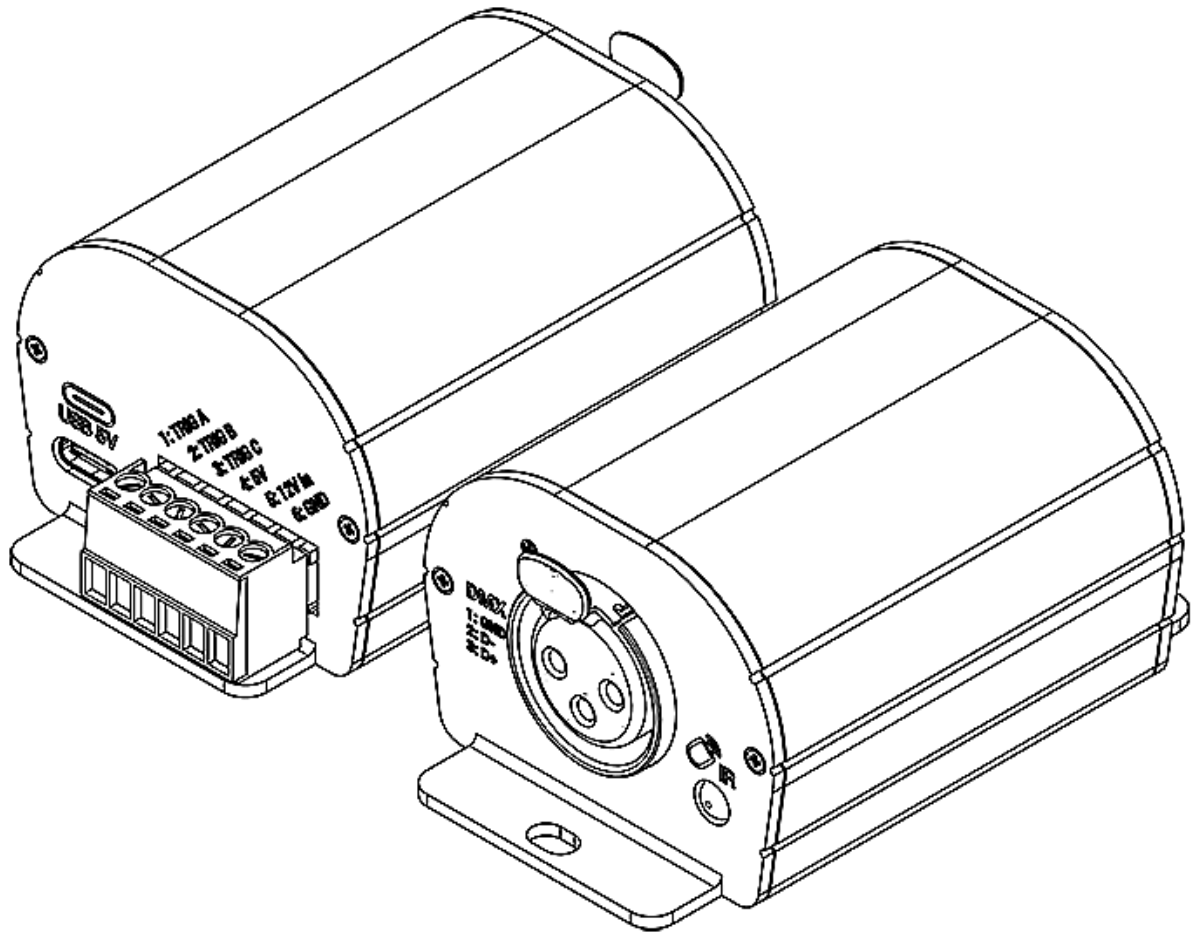

Datasheet &
Quickstart Guide

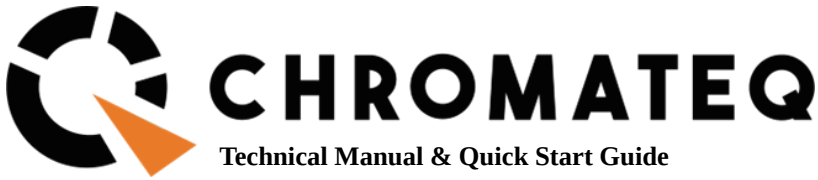

Congratulations on your purchase of a CHROMATEQ controller.

Please read this manual carefully and thoroughly before using the CLUB Chromateq.

The information presented here provides a useful introduction to the wide range of features, settings and functions available in this compact and versatile CLUB

The CLUB Technical Manual is written in English and French.
(Le manuel technique du CLUB est rédigé en anglais et en français.)

All products and software are developed and designed in France.

CHROMATEQ SARL

191 Allée de Lauzard 34980 St Gély du Fesc FRANCE VAT: FR18521458034 Siret: 52145803400027 Web & E-mail:
www.chromateq.com Phone: +33 952210755 / +86 13422062209 Whatsapp: +8613422062209 Wechat: Chromateq QQ:
2908265661

Twitter: <https://twitter.com/Chromateq>

Facebook: <https://www.facebook.com/ChromateqCompany/>

YouTube: <https://www.youtube.com/c/chromateq>

Copyright Information and Disclaimer

Copyright © 2021 - CHROMATEQ. All rights reserved.

No part of this publication may be reproduced, distributed or transmitted in any form or by any means whatsoever, including photocopying, recording or other electronic or mechanical methods, without the prior written permission of the publisher, except in the case of brief quotations in criticisms and certain other non-commercial uses permitted by copyright law.

For any request for authorization, write to the publisher at the address above.

Trademark credits

Microsoft and Windows are U.S. registered trademarks of Microsoft Corporations. Art-Net™ - Designed by and Copyright Artistic License Holdings Ltd. All other products mentioned herein may be trademarks of their respective ® companies.

Package Contents

- 1x CLUB
- 1x USB cable
- 1x Power supply 9-12V DC (Euro/US socket)
- 1x software download link and technical documentation

Caution: Check the contents of the package and the condition of the interface after unpacking! Contact your supplier if something is missing or is damaged. Do not use the device if it appears to be damaged!

Table des matières

Introduction.....	5
Main features.....	5
Hardware technical specifications.....	5
Software options.....	6
Housing connectivity	7
Front panel.....	7
Rear panel.....	7
USB drivers installation	8
Multiple USB connections.....	8
Standalone mode settings	9
Device configuration	9
IN/OUT tab	9
"Merge DMX In / DMX Out" option.....	10
Art-Net/sACN universe range:.....	10
Options tab	11
Commands tab.....	12
Scenes selection and configuration	13
Choice of triggers.....	13
Infrared Trigger.....	14
External contacts Trigger:.....	14
Triggers via Wi-light 2 app and UDP commands.....	16
Advanced trigger options.	16
Restore after power off.....	16
Play in priority.....	16
Save in memory option.....	17
Basic backup.....	17
Save to an internal and external micro SD card.....	18
Backing up Art-Net or sACN to an external SD card	18
Stand-alone use.....	19
Switch to stand-alone mode.....	19
External and USB power supply.....	19
How to use IR Remote.....	19
Previous Remote Control Unit (Before 2022).....	19
Functioning for Interfaces without Mode and older interfaces.....	19
Functioning for Interfaces with Modes.....	19
New Remote Control Unit (2022).....	20
Functioning for Interfaces without Mode and older interfaces.....	20
Functioning for Interfaces with Modes.....	20
Functions descriptions.....	21
IR Codes.....	22
IR receiver box.....	22
Housing dimensions in mm.....	23

Front.....	23
Back.....	23
Tops.....	23
Troubleshooting	24

Introduction

Our professional package for entry-level budgets and users seeking an easy-to-operate DMX control system.

Newly designed aluminium housing with beautiful finish and updated electronics that work with all the latest 2022 Chromateq software (as well as older versions of LED Player and Pro DMX).

Capable of 3 trigger options and equipped with DC 5-18V input this USB to DMX controller includes USB 5V power supply and an optional infrared remote control in the package.

It is the perfect hardware for easy integration projects.

Objectives

The purpose of this technical manual is to develop the options managed by the interface in standalone mode, for software options, please refer to the software manuals

Main features

Hardware technical specifications

Input	USB 2.0 via USB-C
Number of DMX Outputs	Up to 128 or 512 on 3 pin XLR (XLR5 optional)
DMX Speed	1 to 45 Hz, MaB, Bk
Stand Alone Mode	Yes, 128 or 512 channels, fine DMX channels (16 bits)
Internal Memory	Yes (200 Kb)
Memory Capacity	200 to 2000 memory steps
Infra-red Receiver	Yes, (IR remote control for triggers available in option)
Infra-red Options	Scene selection, play, pause, speed, dimmer, next, black out
Dry Contact Triggers	Yes (3 smart contacts port with 7 actions max)
Power Supply Input	5V via USB-C + 5~18V DC from connector, 0,1A
High voltage Protection	Yes
Housing	Strong Aluminium
Infrared remote	Not included (optional, need IR Kit)
USB Mode	Yes
Display of signal states	USB LED
Power	0,5 W
CPU's technology	32 bits
Dimensions	H : 55mm(2.16in) / W : 50mm(1.96in) / D : 37,5mm (1.47in)
Weight	0.085 Kgs
Package total weight	0.15 Kgs
Colour	Black

IP rating	IP40
Place of Use	Indoor
Storage	Keep in dry place
Compatibility	8 and 16 bits DMX 512 fixtures
Operating Temperature	-25 to +70 C°
Certifications	CE, RoHS, Fcc
International Warranty	Yes, 1 year

Software options

PLAYER , PRO, PRO2	128 or 512 channels Live and Stand Alone
Studio DMX 3D viewer	Yes, real time
Art-Net Output from PC	No
Wi-Light 2 App	Yes, software control from mobiles and LAN and WLAN
System Compatibility	Windows, MAC Os X (10.6 and higher) and Linux (64 Bits)
Free Software Updates	Yes

Housing connectivity

Front panel

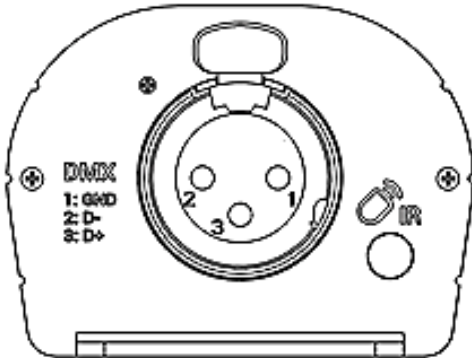

XLR Connector 3 pins

- 1: Ground
- 2: Data -
- 3: Data +

Infrared Receiver LED, (Remote unit is optional)

Rear panel

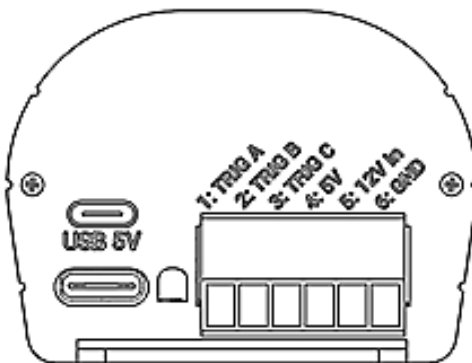

USB-C Connector (5V DC input)

Green USB Signal LED

Terminal Block Connector with screws

- 1 to 3: Trigger A, B, C
- 4: Power output for triggers A, B, C, 5V DC
- 5: Power Input 5-18V DC ; 0,1A or VCC (V+)
- 6: Ground (V-)

USB Signal LED operating states

OFF	Interface not powered (check the USB cable or the power supply)
ON	Interface powered, No scene is playing
Fast Blinking	USB communication running with the software
Slow Blinking	Stand Alone mode and playing a scene
Flashing very fast	In bootloader mode, waiting to load a new firmware

USB drivers installation

Install USB drivers to communicate with the device and change settings.
Installation of USB drivers is required only for Windows at the end of installation.
Drivers for Mac and Linux systems are installed automatically.

USB drivers verification :

In the Windows Device Manager. Check that the device icon is visible in "USB Bus Controllers".

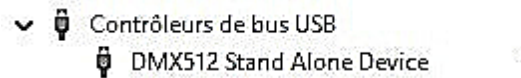

If drivers are not installed, the Windows Device Manager lists a device with a yellow warning.

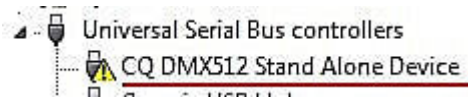

On Mac OS, simply check the USB device tree to view "DMX 512 Stand Alone Device". On Linux, use the "lsusb" command to view "DMX 512 Stand Alone Device" as a list.

After control software installation and USB drivers

- Connect the device with the USB cable.
- Start the DEVICETOOL or the software and select "Open USB Device" or "USB" to check the success of drivers installation.

All connected and detected devices are listed.

Multiple USB connections

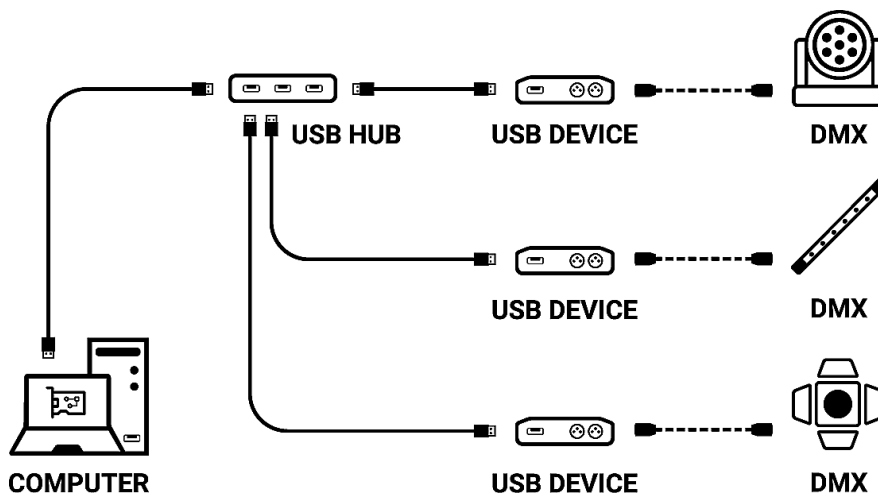

Standalone mode settings



In standalone mode of the control software, configure the device according to the available options then select and configure the triggers of scenes to be written in memory.

Device configuration

IN/OUT tab

Select a DMX input/Output configuration of the interface from the drop-down menu

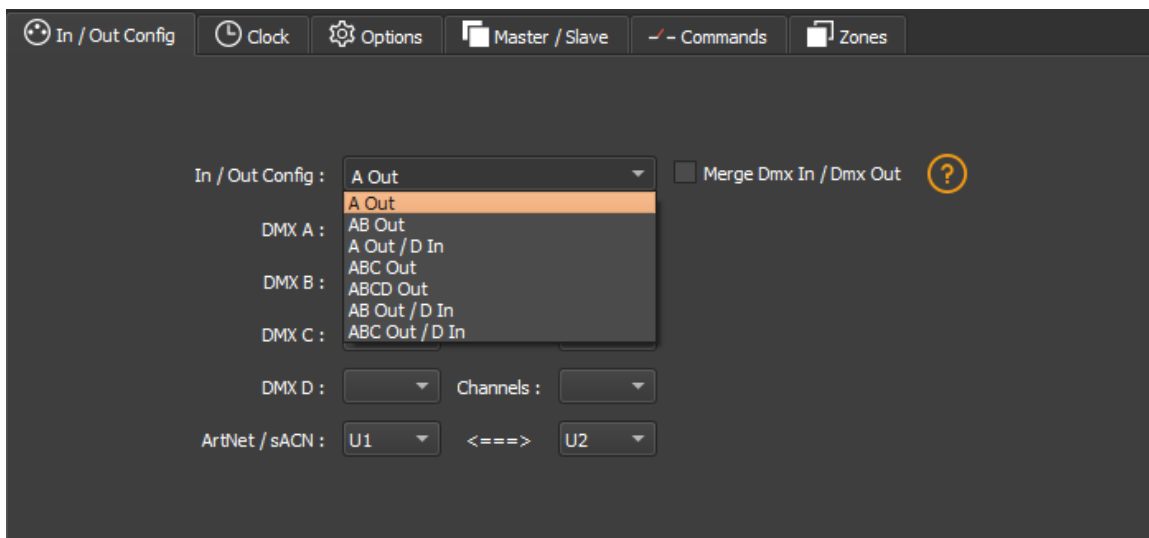

Available configurations will be displayed depending on the connected device depending on whether it has 1.2 or 4 DMX lines.

- **A OUT** - Assigns 1 output universe on the DMX line(s), for devices that have more than 1 DMX lines duplicate the universe on each.
- **AB OUT** - Assigns 1 different output universe on 2 DMX lines, for devices that have 4 DMX lines duplicates the first 2 lines on the next 2 lines.
- **A OUT/B or D IN** - Assigns 1 output universe on the first line(s) and uses the last DMX line as DMX input.
- **ABC OUT** - Assigns 1 different universe output on the first 3 DMX lines.
- **ABCD OUT** - Assigns 1 different universe output on 4 DMX lines.
- **AB OUT / D IN** - Assigns 1 different output universe on the first 2 lines and uses the last DMX line as DMX input.
- **ABC OUT / D IN** - Assigns 1 different output universe on the first 3 lines and uses the last DMX line as DMX input.

"Merge DMX In / DMX Out" option

Available with interfaces with more than 2 or 4 DMX lines.

Enable the option to re-inject line configured as an input (IN) to the line(s) configured in DMX outputs and thus merge them.

The merged DMX levels are compared and the highest is retained. We are talking about HTP (Highest Takes Priority).

Maintain manual control on some circuits with an external DMX console.

Create a multi-zone system by merging several cascading interfaces to obtain only one common DMX line.

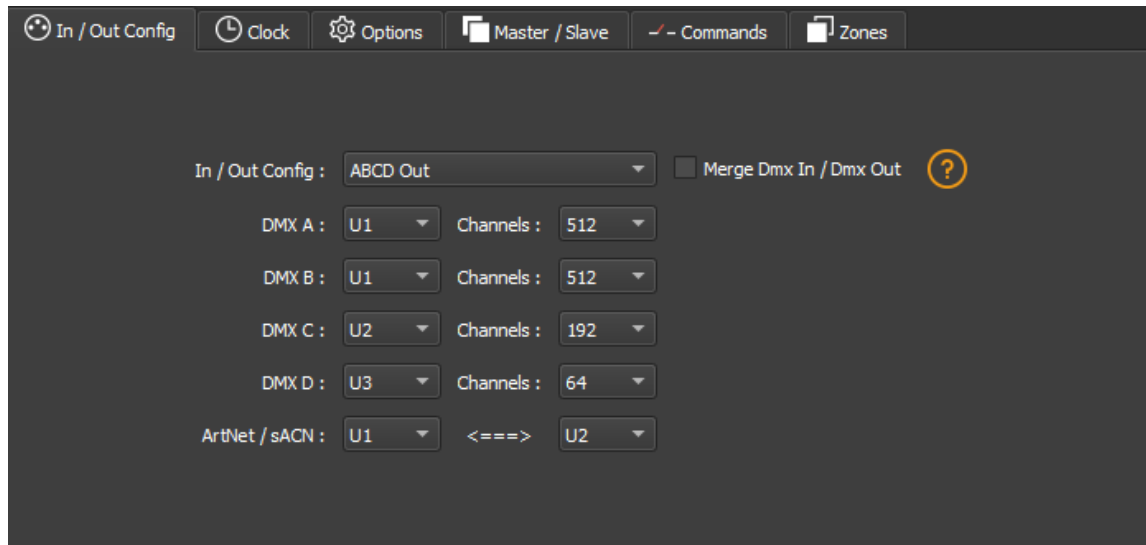

Assign any universe of the software to any DMX line assigned to output, choosing line by line (U1, U2...).

Optimize the size of shows saved in memory by reducing the number of circuits per universe depending on the channels used.

Example: If 150 channels are used in the show, select only the nearest higher value, here 192.

Art-Net/sACN universe range:

Define the starting universe and the finish universe to write in memory on an external SD card for an Art-Net/sACN show.

Cf: *"Saving Art-Net or sACN to an external SD card"*

Options tab

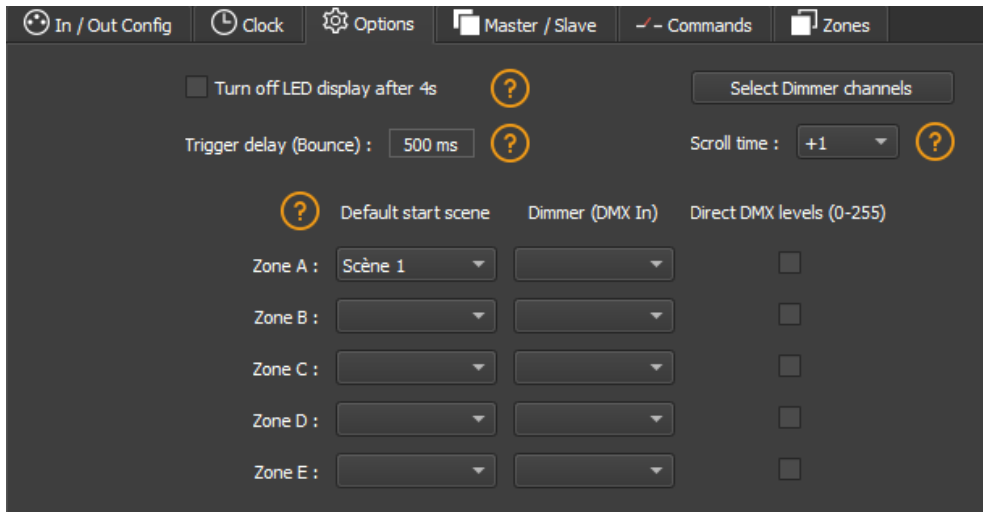

For devices with an LED display, turn it off after 4 seconds of inactivity by checking the option.

Select a default scene to play automatically after the interface is turned on (with USB or external power supply). For multi-zones devices it is possible to set a default scene for each area.

Note: The selected default start scene loses its priority if another scene uses the "Restore if power off" option.

Cf: "Advanced trigger options"

Configure the "Select Dimmer channels" option to select separately the Dimmer or RGBW light intensity channels that will be controlled directly by Dimmer mode, dry contacts or via the infrared remote control.

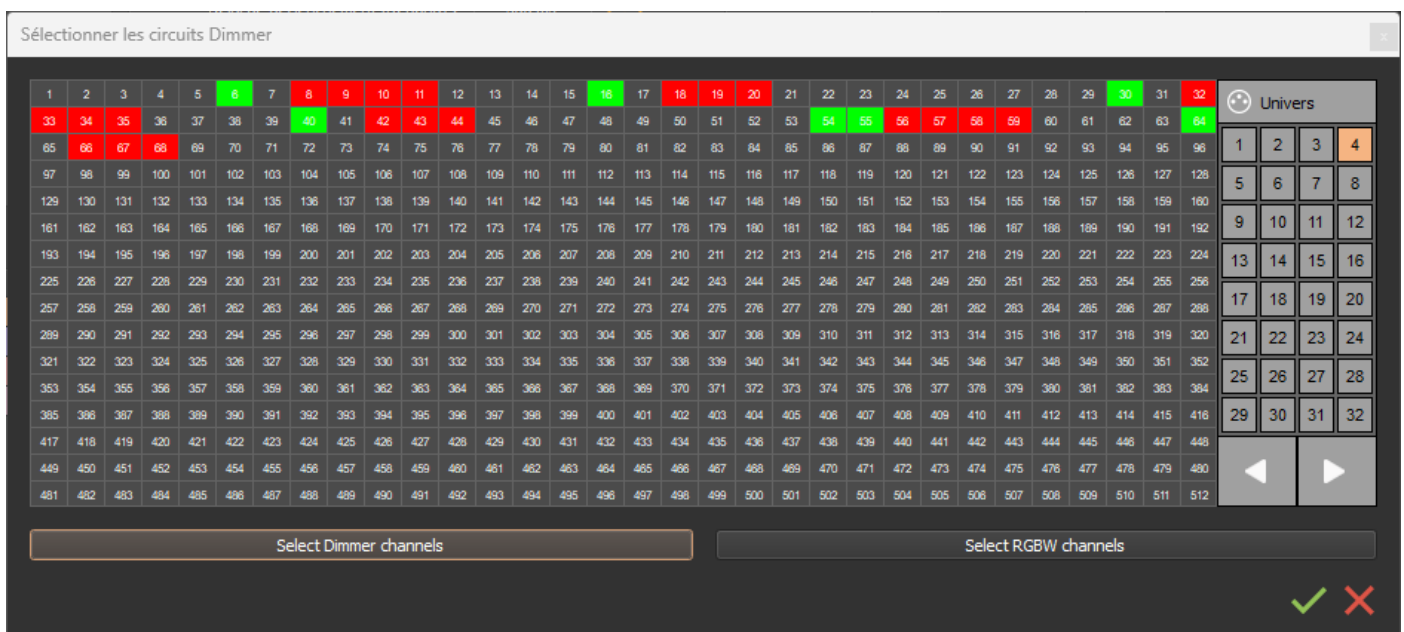

Commands tab

Assign external contacts, among those available for your device, to trigger some standalone mode commands: Dimmer +, Dimmer -, Blackout, Speed +, Speed -, Pause, Scene +, Scene - and Zone.

Note: Be careful not to use the same command trigger as the one used for a scene and vice versa. Cf: *"Choice of triggers by external contacts"*

The last assigned contact will take priority over the other.

Use 2 types of Short/Hold contact and thus assign an identical contact to 2 different commands. (here as an example with the Dimmer +; Dimmer -)

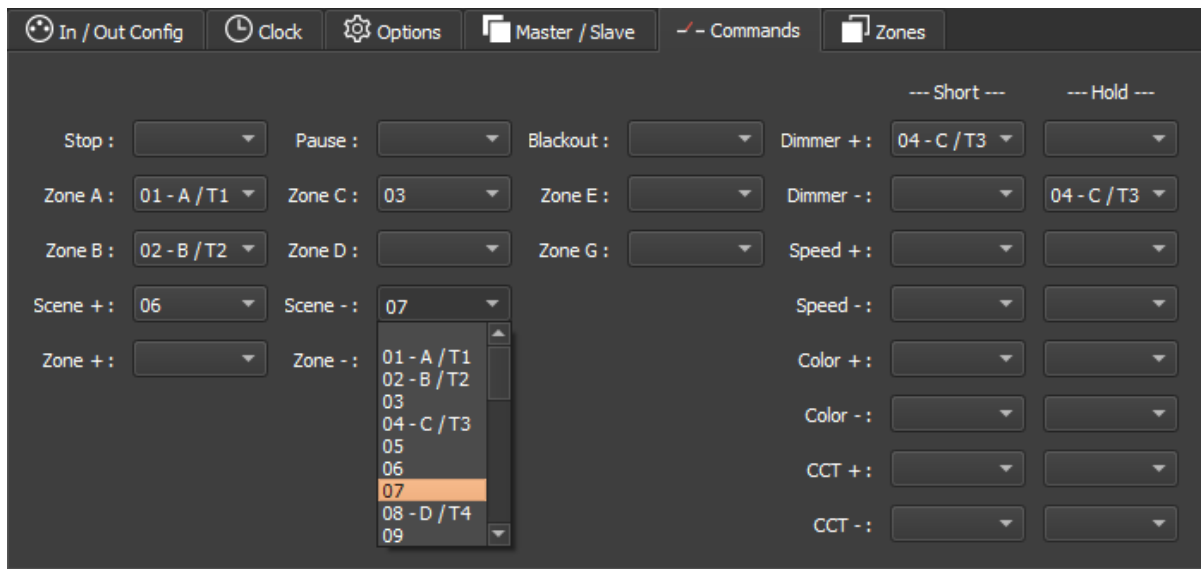

Scenes selection and configuration

The interface shows a table of scenes and a configuration panel for a device named RS232.

	Name	Duration	Properties	Triggers	Zone
1	Scène 1	00m 04s 000	00:00:000 #oo	●	A
2	Scène 2	00m 09s 960	00:00:000 #oo	●	A
3	Scène 3	00m 11s 000	00:00:000 #oo	●	A
4	Scène 4	00m 02s 000	00:00:000 #oo	●	A
5	Scène 5	00m 02s 000	00:00:000 #oo	●	A
6	Scène 6	00m 02s 000	00:00:000 #oo	●	A
7	Scène 7	00m 02s 000	00:00:000 #oo	●	A
8	Scène 8	00m 03s 000	00:00:000 #oo	●	A
9	Scène 2	00m 03s 000	00:00:000 #oo	●	B
10	Scène 3	00m 02s 400	00:00:000 #oo	●	C
11	Scène 4	00m 09s 960	00:00:000 #oo	●	D

The configuration panel for device RS232 includes the following options:

- Restore if power off (checkbox)
- Play in priority (checkbox)

At the bottom of the interface, there is a progress bar showing 1% completion and a refresh icon.

Check to select the scenes to write in memory and assign triggers from those available by your device.

Choice of triggers

In the "Triggers" tab, select and assign different types of triggers.

The 'Triggers' tab for device RS232 displays the following options:

- Restore if power off (checkbox)
- Play in priority (checkbox)

There are also several trigger icons (a speaker, a radio signal, a red line, and a smiley face) each with a dropdown menu and a question mark icon, indicating that triggers need to be assigned.

Infrared Trigger

For devices that do not have this trigger option an Infrared kit is available containing an IR receiver and a remote control.

Cf: "use of the remote control by infrared"

Select a scene from the list and assign it a remote control button from the 15 available buttons.

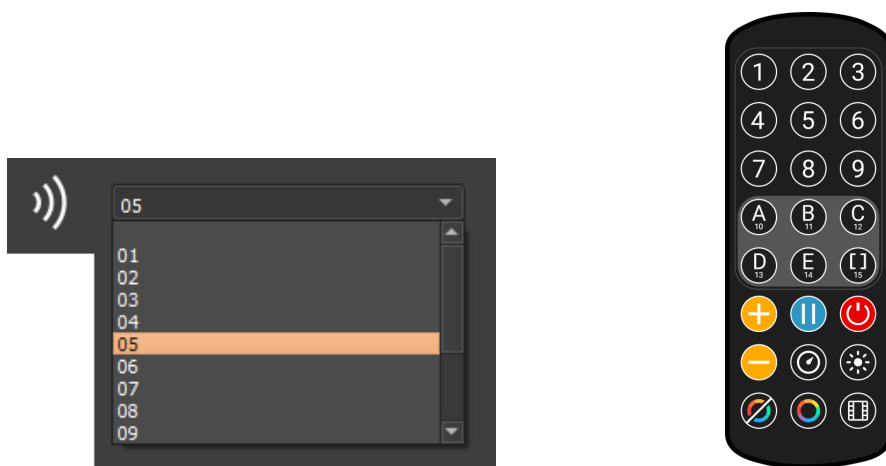

Automatically assign buttons to all scenes in the list by clicking the Infrared icon on the scene list toolbar.

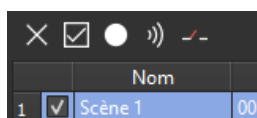

External contacts Trigger:

Depending on the interface, several external contacts are available: Trig A, Trig B, Trig C ..., and the Use a multiplexing interface to extend the number of contacts when possible. (from 3 to 7; from 4 to 15; from 5 to 31 ...) Contact reaction time, 5ms (0.005s)

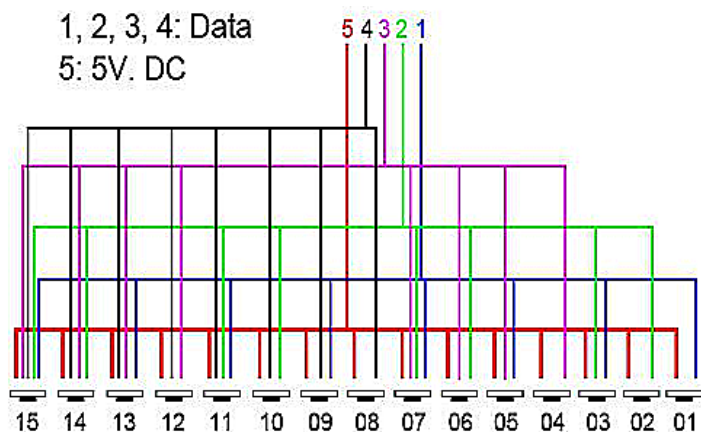

Example of multiplexing system with 4 external contacts extended to 15.

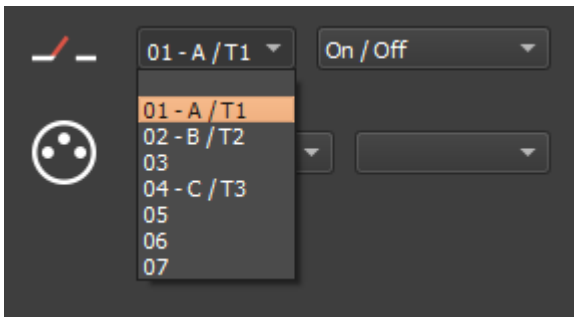

Select a scene from the list and assign it a contact from those available through the interface.

Option of triggers

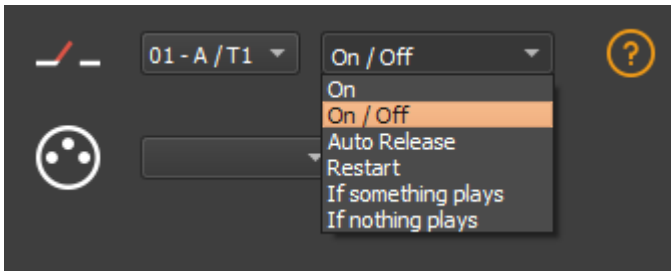

Select a trigger option from the drop-down menu next to it.

On: Activating the contact makes the scene play (the only trigger action is to start the scene).

On/Off: Activating the contact starts the scene, subsequent activation stops the scene. Each trigger action will reverse the stage state (start/stop).

Auto Release: The scene is played only while the contact is enabled. When the contact is released, the scene stops.

Restart: If the scene is playing, enabling the contact restarts the scene from its beginning. If the scene is not being played, it will start. External contact reaction time: 8 ms (0.008 s) / time between 2 contacts: 500 ms (0.5 s)

If something plays: Play the selected scene if a scene is already played.

If nothing plays: Play the selected scene if nothing plays.

These two interdependent options allow the same contact to be assigned to two different scenes.

Note: Be careful not to use the same scene trigger as the one used for a command and vice versa. Cf: "Order tab"

The last assigned contact will take precedence over the other.

Automatically assign external contacts to all scenes in the list by clicking the external contact icon on the scene list toolbar.

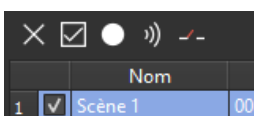

Triggers via Wi-light 2 app and UDP commands

When connected to a local network with a WIFI access point, it is possible to trigger and control the interface with the Wi-Light 2 app for Android and iOS when it runs in standalone mode. This local mode is also available on the internet with the Web Remote option.

Each device, interface and mobile, must be connected to the same access point in DHCP (recommended) or fixed IP mode. The application will then detect the interface and display the list of scenes and other possible controls and commands. The Web Remote control option requires you to create a user account and save your interfaces locally first. Please refer to the Wi-Light 2 manual to use this mode.

The Wi-Light 2 app uses an open protocol for developers with standard communication based on simple UDP commands.

Third-party software can establish UDP communication with the software/interface and control it using predefined JSON commands. Option only available with interfaces with an Ethernet port. (see "Communication Development Kit User Manual")

Advanced trigger options.

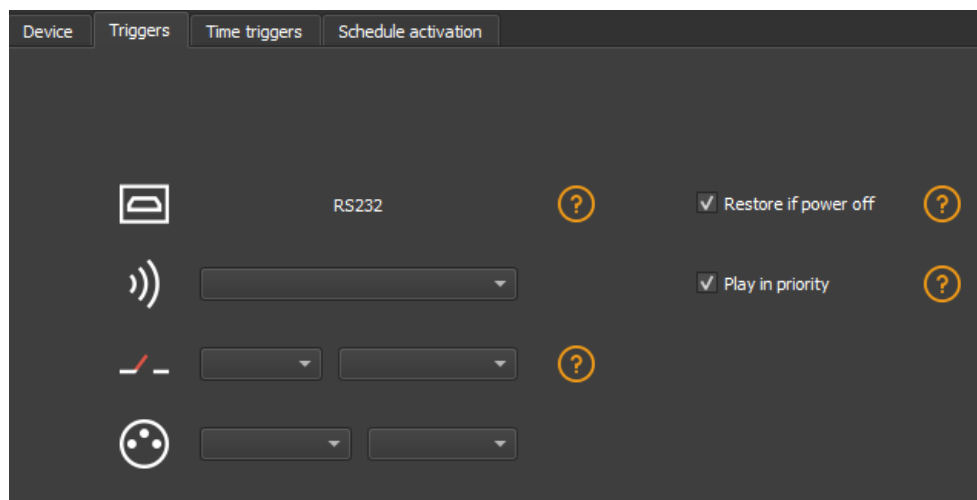

Restore after power off

By checking this option in the "Triggers" tab, the selected scene takes priority on the boot scene (see "Options tab") when the power supply is restored.

If all scenes have the option checked, the last active scene is replayed.

Play in priority

By checking this option in the "Triggers" tab, the selected scene plays continuously until its end, without taking into account other triggers, except for time triggers and physical buttons on the device.

Save in memory option

Check scenes that need to be saved in memory.

	Name	Duration	Properties	Triggers	Zone
1	<input checked="" type="checkbox"/> Scene 1	00m 14s 400	00:05:000 #00		A
2	<input checked="" type="checkbox"/> Scene 3	00m 00s 480	00:03:000 #00		A
3	<input checked="" type="checkbox"/> Scene 4	00m 05s 720	00:05:000 #1		A
4	<input type="checkbox"/> Scene 5	00m 18s 000	00:07:000 #1		A
5	<input type="checkbox"/> Scene 6	00m 05s 000	00:00:000 #00		A
6	<input checked="" type="checkbox"/> Scene 6_copy_1	00m 05s 000	00:00:000 #00		A
7	<input type="checkbox"/> Scene 6_copy_2	00m 07s 000	00:00:000 #00		A
8	<input type="checkbox"/> Scene 6_copy_3	00m 07s 000	00:00:000 #00		A
9	<input type="checkbox"/> Scene 6_copy_4	00m 07s 000	00:00:000 #00		A
10	<input type="checkbox"/> Scene 6_copy_5	00m 07s 000	00:00:000 #00		A
11	<input type="checkbox"/> Scene 6_copy_6	00m 07s 000	00:00:000 #00		A
12	<input type="checkbox"/> Scene 6_copy_7	00m 07s 000	00:00:000 #00		A
13	<input type="checkbox"/> Scene 6_copy_8	00m 07s 000	00:00:000 #00		A
14	<input type="checkbox"/> Scene 6_copy_9	00m 07s 000	00:00:000 #00		A
15	<input type="checkbox"/> Scene 16	00m 03s 000	00:05:000 #3		A
16	<input type="checkbox"/> Scene 17	00m 08s 000	00:00:000 #2		A
17	<input type="checkbox"/> Scene 18	00m 03s 200	00:00:000 #40		A
18	<input type="checkbox"/> Scene 19	00m 13s 000	00:00:000 #2		A
19	<input type="checkbox"/> Scene 20	00m 04s 000	00:00:000 #2		A
20	<input type="checkbox"/> Scene 21	00m 03s 500	00:00:000 #2		A

Click on the "Write in Memory" button

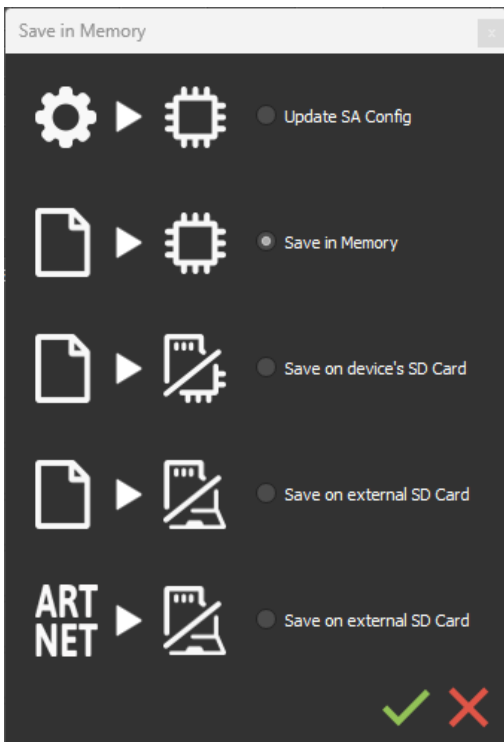

Select the desired option in the Scenes Write window.

Basic backup

Write standalone configuration: Change only certain settings in the configuration of a show already written in memory. Reduces backup time.

Write to Memory: Default backup in the internal memory of the device.

Save to an internal and external micro SD card

For devices with a micro SD port.

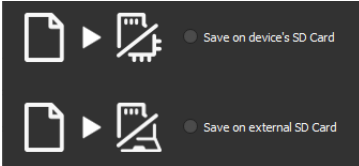

Save scenes to a micro SD card (Class 10) installed in the device's SD card reader or in the computer drive. The card must be CLASS 10, formatted in FAT or FAT 32 with a maximum capacity of 256 GB. It is recommended to use the largest allocation unit size available when formatting.

Write to the SD card of the device: SD card installed in the interface drive

Write to an external SD card: SD card connected to the computer

Note: Save to the root directory of the SD card.

Backing up Art-Net or sACN to an external SD card

For devices with a micro SD port and an Ethernet port.

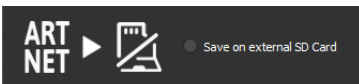

Art-Net - Write to an external SD card: Save up to 8 universes only on micro SD to render an Art-Net or sACN show independently.

Set the universe range in the IN/OUT config tab. Cf:

Pre-commissioning verification:

Connecting the RJ45 cable before power on.

Connection to the local network. Cf: "Ether Ethernet connection and configuration"

Configuring the device in Art-net or sACN mode via the software or DeviceTool.

Note: Once in Art-Net (Ar) or sACN (AC) mode, the interface is no longer visible on the local network.

In Art-Net the interface will use Broadcast to play the show on the network.

In sACN the interface will use the Multicast to play the show on the network.

Stand-alone use

Switch to stand-alone mode

The interface switches to standalone mode automatically after 5 seconds after power on and if no software connection is made.

External and USB power supply

The external power supply is only used for "Autonomous" mode. But it is possible to connect a USB cable and power supply at the same time, even if this configuration is not recommended. If a USB cable is connected to the interface when running in standalone mode, the device will detect a possible connection to a computer but this will not affect the scenes that play.

How to use IR Remote

Infrared Remote triggers work in Stand Alone and in Live mode when "Get Stand Alone Triggers" is checked in software option window, at the bottom of "Device" section.

Get Stand Alone triggers

Previous Remote Control Unit (Before 2022)

Functioning for Interfaces without Mode and older interfaces.

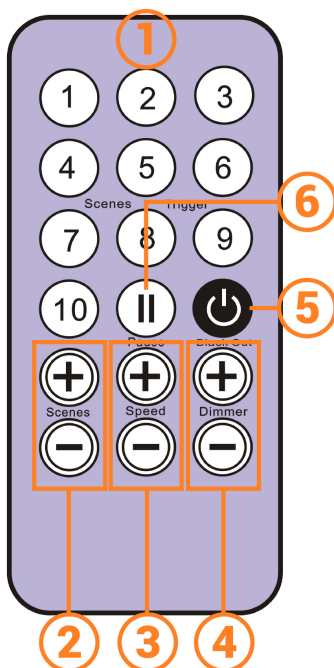

1. **Scene trigger buttons** (1 to 10) assigned via the software.
2. **Scene selector**, next or previous.
3. **Speed value**, increase & decrease
4. **Dimmer value**, increase & decrease
5. **Blackout**: Stops the current scene and plays the scene 00. All DMX levels are set to zero.
6. **Pause**: Freezes the current scene in its state

Functioning for Interfaces with Modes

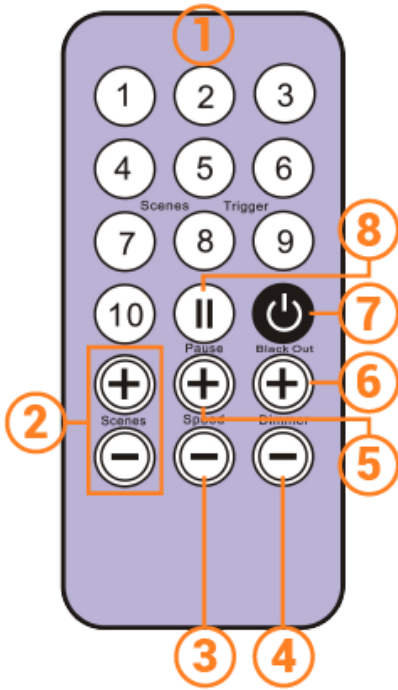

1. **Scene trigger buttons** (1 to 10) assigned via the software
2. **Increase or decrease** the value of the selected mode:
Scene +/-, Dimmer +/-, Speed +/-, Color +/-.
3. **Color mode**
4. **Scene mode**
5. **Dimmer mode**
6. **Speed mode**
7. **Blackout:** Stops the current scene and plays the scene 00.
All DMX levels are set to zero.
8. **Pause:** Freezes the current scene in its state.

New Remote Control Unit (2022)

Functioning for Interfaces without Mode and older interfaces.



1. **Scene trigger buttons** (1 to 10) assigned via the software.
2. **Scene selector**, next or previous.
3. **Speed value** decrease
4. **Speed value** increase
5. **Dimmer value** decrease
6. **Dimmer value** increase
7. **Blackout:** Stops the current scene and plays the scene 00. All DMX levels are set to zero.
8. **Pause:** Freezes the current scene in its state

Functioning for Interfaces with Modes



1. **Scene trigger buttons** (1 to 15) assigned via the software Trigger 1 to 15 with 1 Zone. Trigger 1 to 9 with several Zone.
2. **5 Control Zones** available: A, B, C, D, E and Global Zone: [] to trigger each Zone in the same time.
3. **Increase or decrease** the value of the selected mode: Scene +/-, Dimmer +/-, Speed +/-, Color +/-.
4. **Release Color mode**
5. **Color mode**
6. **Scene mode**
7. **Dimmer mode**
8. **Speed mode**
9. **Blackout:** Stops the current scene and plays the scene 00. All DMX levels are set to zero.
10. **Pause:** Freezes the current scene in its state.

Functions descriptions

Scene +/-: Each push selects the next or previous scene of the current Zone. Scene are play immediately.

Master Dimmer: Increases or decreases the RGB, CMY and dimmer channels of the current zone. The CMY, RGB, Dimmer channels are defined in the Profile of the fixture and the stand-alone mode.

Scene Speed: Increases or decreases the speed of the current scene in the current zone. A different speed can be chosen separately for each scene.

Zones: Choose a Zone (A,B,C,D,E or Global []). Then select a scene or mode to trig in the selected zone.

Modes: Select a Mode from Speed, Dimmer, Color or Scenes, then use +/- to change values.

IR Codes

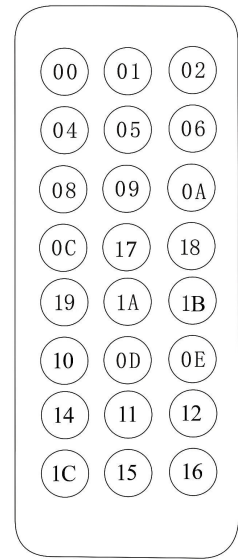
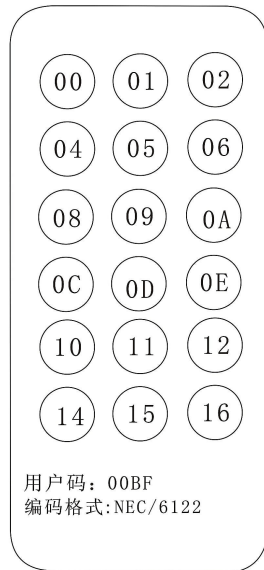
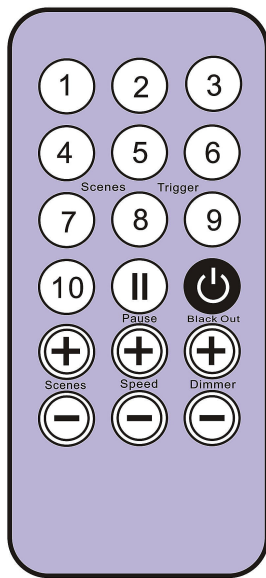

IR receiver box

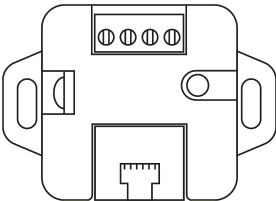

To use the optional IR remote control, an external circuit with an IR receiver must be connected via an RJ45 port or via the stand-alone interface terminal block.

IR PCB pinout

- With RJ45 cable, use pins: #8 = Ground; #4 = IR data; #7 = 5V.
- With connectors, use pins: O = IR data; V = 5V; G = Ground.

Maximum distance from cable to receiver is approx. 20 m.

Light sensor

The light sensor integrated in the IR box circuit **only works with hourly triggers**. The external card must be connected via the RJ45 port or via the terminal block. Light sensitivity must be set in the software.

See "Time-controlled scenes".

Housing dimensions in mm.

Front

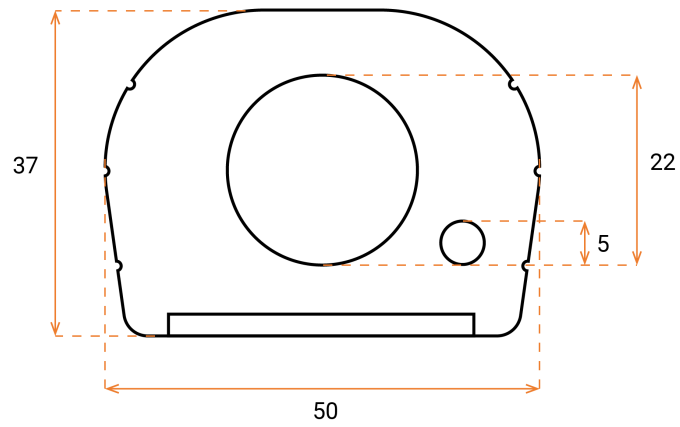

Back

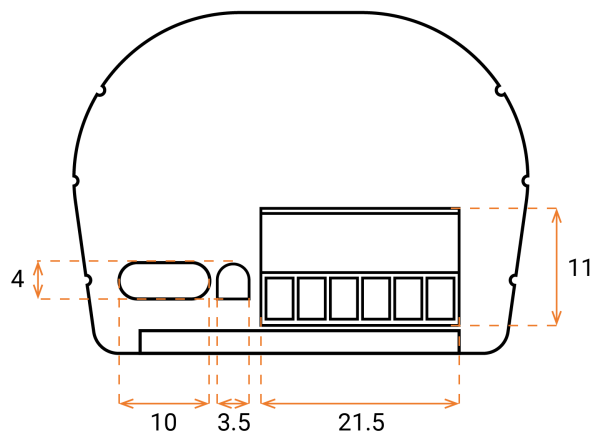

Tops

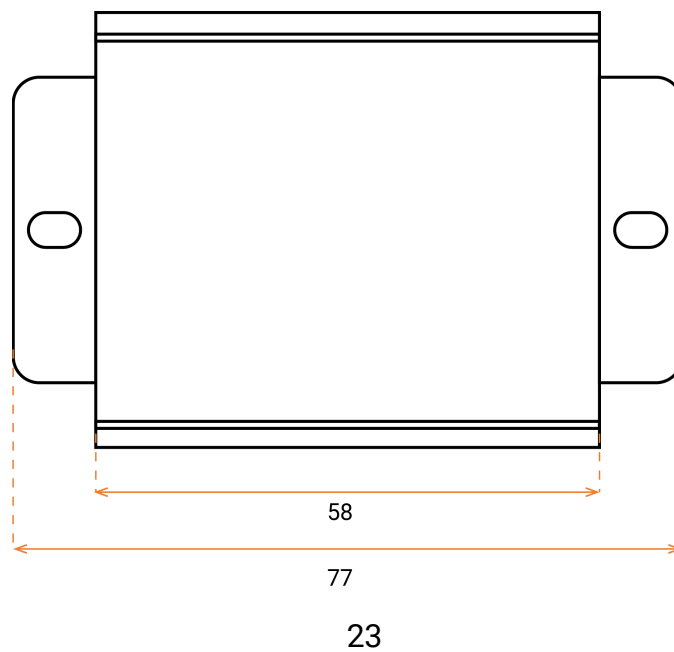

Troubleshooting

The device is not detected by the DeviceTool or USB software.	<p>Unplug to restart the device.</p> <p>Change the USB cable</p>
The device is not detected by the DeviceTool or Ethernet software.	<p>Unplug to restart the device.</p> <p>Change the Ethernet cable</p> <p>Check the selection of the Ethernet network before opening.</p>
The device is not detected on the network.	<p>Check the mode of communication with LED signals and reconfigure the device via USB if necessary</p> <p>Verify that the IP addresses and subnet mask are configured correctly.</p> <p>Update the firmware of the device via the software or DeviceTool</p> <p>Update the software with the latest version and try again</p> <p>Open and allow communication ports used by the device. Some local networks may require manual opening of the following UDP Ports: 8011 + 8012 for communication between the device and software.</p>
The device is blocked in standalone mode and it cannot establish communication with the software.	<p>Check the firmware and software version.</p> <p>Device with display When working properly: The screen indicates "ON" when connected to the computer, then it displays "SA" and "00" (or a scene number). When you start the software and the interface is properly detected, you should see "PC".</p> <p>Device without display Check the mode of communication with LED signals.</p> <p>During the 5 seconds before the device switches to standalone mode:</p> <ol style="list-style-type: none"> 1) Create a small show with a scene (in demo mode) and close the software after saving the show.(optional) 2) Unplug the interface. 3) Start the software and wait for the software to be on the 1st page of the wizard with the selected USB device.

	<p>4) Plug in the interface and start the software IMMEDIATELY .Simply confirm all the steps of the wizard.You should see the interface well detected and listed in the wizard.</p> <p>5) Open the software and quickly write the small show in memory.</p> <p>Writing a new scene cleanses memory and does not allow the infinite loop to reproduce.</p>
<p>The device does not restore the Art-Net or sACN show.</p>	<p>Before commissioning, plug the RJ45 cable before powering.</p>
	<p>Replugging the power supply</p>
	<p>Insert the SD card again (Reset)</p>
	<p>Device with display Select ArtNet (Ar) mode again, sACN (AC) in the advanced F3 menus of the interface (mode button).</p> <p>Device without display Select ArtNet, sACN mode again via the software or DeviceTool.</p>

If you experience unlisted issues, contact your seller or manufacturer directly to indicate your problem and receive a solution.

Product design and specifications are subject to change without prior notice.

Older devices (sold before 2020) are not compatible with PRO DMX version 2



191 Allée de Lauzard
34980 St Gély du Fesc, FRANCE
Web: www.chromateq.com
Email: info@chromateq.com
Phone: +33 952210755

Wechat: Chromateq
WhatsApp: +8613422062209
QQ: 2908265661



Guaranteed products: 1-3-5 years
Software pack: <https://chromateq.com/dmx-software-downloads/>

Copyright © 2021 - CHROMATEQ.All rights reserved.